

RADIO'S LIVEST MAGAZINE



February
25 Cents
Canada 30c

Radio-Craft

HUGO GERNSBACK Editor

How to Make the
"AMPLITENNA"
Capacity Aerial
See Page 458



The A. C. Meterless Tube Tester—Multiple Speakers—A Long-Wave Tuner
Building a Resistance Tester—Cartoon Advertising in Radio



McMURDO~SILVER

The
MASTERPIECE
of the
MASTER
DESIGNER

I designed it, but I did not name it.

Impartial laboratory instruments did that. They measured this receiver. Also the others it was designed to out-perform.

Their verdict was . . . "so far ahead of anything else that comparison is utterly impossible."

Indisputable mathematical facts, therefore designated that this receiver be known as "The Masterpiece."

You will agree that it has been correctly named . . . when you see its performance curves.

You will KNOW it is the greatest advancement in radio since the screen grid tube . . . when you make a personal test of The Masterpiece side by side with all other so called "custom-built" 15-550 meter receivers.

Now . . . with the coming of The Masterpiece you can actually "get" foreign reception with regularity and certainty—irrespective of where you live.

Now . . . you can tune from 15-550 meters without changing coils . . . without using trimmers . . . without attaching a separate antenna tuner . . . and without consulting blue prints, charts or station finders. The four wave bands are right on the Masterpiece dial and are calibrated to absolute accuracy from 15 to 550 meters.

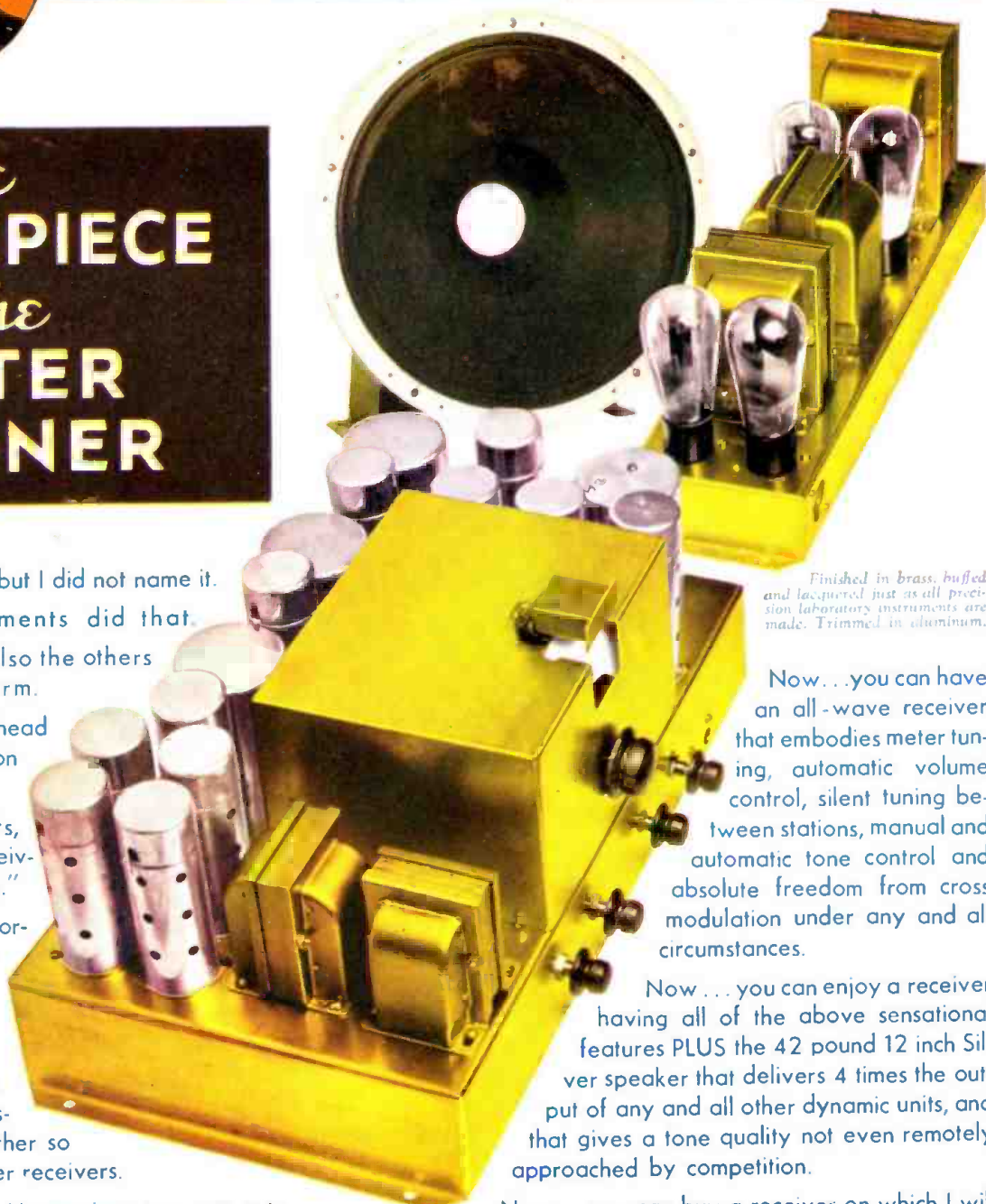

Finished in brass, buffed and lacquered just as all precision laboratory instruments are made. Trimmed in aluminum.

Now . . . you can have an all-wave receiver that embodies meter tuning, automatic volume control, silent tuning between stations, manual and automatic tone control and absolute freedom from cross modulation under any and all circumstances.

Now . . . you can enjoy a receiver having all of the above sensational features PLUS the 42 pound 12 inch Silver speaker that delivers 4 times the output of any and all other dynamic units, and that gives a tone quality not even remotely approached by competition.

Now . . . you can buy a receiver on which I will have personally logged three or more foreign stations outside of North America, and that is accompanied by its own specific performance curves measured on your exact set and tubes by me personally.

And last, but of no less importance, The Masterpiece comes to you for a 10 day free trial in your home . . . subject to any kind of competitive test you can think of. If you are not satisfied in every way, you may return The Masterpiece for a prompt and full cash refund.

The coupon at left and 6 cents in stamps will bring my 16 page book giving complete technical description of The Masterpiece. Clip . . . Mail the coupon now.

McMURDO SILVER, INC.
1132 WEST AUSTIN AVENUE, CHICAGO, ILLINOIS, U. S. A.

McMURDO SILVER, INC., 1132 W. Austin Ave., Chicago, U. S. A.
6c in stamps enclosed. Send technical description of The Masterpiece.
Name: _____
Street: _____
Town: _____ State: _____

LEARN RADIO IN 10 WEEKS!

PAY FOR YOUR TRAINING PAY AFTER YOU GRADUATE

I am making an offer that no other school has dared to do. I'll take you here in my shops and give you this training and you pay your tuition after you have graduated. Two months after you complete my course you make your first payment, and then you have ten months to complete your payments. There are no strings to this offer. I know a lot of honest fellows haven't got a lot of money these days, but still want to prepare themselves for a real job so they won't have to worry about hard times or lay offs.

I've got enough confidence in these fellows and in my training to give them the training they need and pay me back after they have their training.

If you who read this advertisement are really interested in your future here is the chance of a life time. Mail the coupon today and I'll give you all the facts.

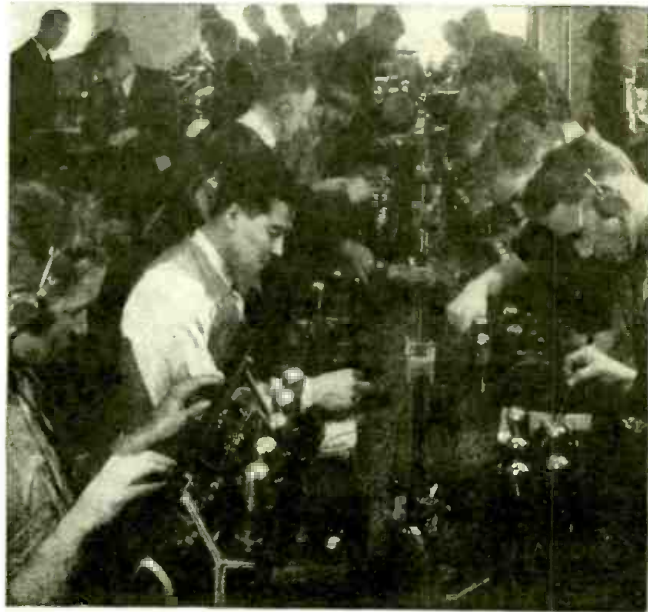

A scene in the big, busy Radio Shops at Coyne. Here you see fellows working on real Radios—not reading about them from books or lessons. This is THE way to prepare for the big-money field of Radio!

TELEVISION *and* TALKING PICTURES

Television is already here! Soon there'll be a demand for THOUSANDS of TELEVISION EXPERTS! The man who learns Television now can have a great future in this great new field. Get in on the ground-floor of this amazing new Radio development! Come to COYNE and learn Television on the very latest, newest Television equipment. Talking Picture and Public Address Systems offer opportunities to the Trained Radio Man. Here is a great new Radio field just beginning to grow! Prepare NOW for these wonderful opportunities! Learn Radio Sound Work at Coyne on actual Talking Picture and Sound Reproduction equipment.

PREPARE NOW and be ready for Radio's many opportunities

Forget pay-cuts—lay-offs—unemployment! Don't be tied down to an untrained man's future. You NEED TRAINING IN A FAST-GROWING MONEY-MAKING TRADE. Here's your chance of a lifetime to get it! Hundreds of opportunities now open in Radio. My sensational offer, explained below, makes it possible for you to START AT ONCE!

The right way to learn Radio is the Coyne way—not by books, but by actual, practical work on actual Radio, Television and Sound equipment. Here at Coyne you'll service and operate scores of modern Radio receivers, huge Broadcasting equipment, late type Television apparatus, Talking Picture machines, Code transmitters and receivers, etc. In 10 weeks you can step into a REAL JOB, leading to a salary of \$50 a week and UP!

ALL PRACTICAL WORK At COYNE in Chicago

ALL ACTUAL, PRACTICAL WORK. You build radio sets, install and service them. You actually operate great Broadcasting equipment. You construct Television Receiving Sets and actually transmit your own Television programs over our modern Television equipment. You work on real Talking Picture

machines and Sound equipment. You learn Wireless Operating on actual Code Practice apparatus. We don't waste time on useless theory. We give you the practical training you'll need—in 10 short, pleasant weeks.

MANY EARN WHILE LEARNING

You get Free Employment Service for Life. And don't let lack of money stop you. Many of our students make all or a good part of their living expenses while going to school and if you should need this help just write to me. Coyne is 33 years old. Coyne Training is tested—proven beyond all doubt. You can find out everything absolutely free. Just mail coupon for my big free book!

H. C. LEWIS, Pres. RADIO DIVISION Founded 1899
COYNE ELECTRICAL SCHOOL
500 S. Paulina St., Dept. 23-8H, Chicago, Ill.

Mail Coupon Today for All the Facts

H. C. LEWIS, President
Radio Division, Coyne Electrical School
500 S. Paulina St., Dept. 23-8H, Chicago, Ill.

Dear Mr. Lewis: Send me your big FREE Book; details of your FREE Employment Service; and tell me all about your special offer of allowing me to pay for training on easy monthly terms after graduation.

Name.....
Address.....
City..... State.....



HUGO GERNSBACK, Editor-in-Chief

LOUIS MARTIN
Associate Editor

R. D. WASHBURNE
Technical Editor

CONTENTS OF THE FEBRUARY, 1933, ISSUE

VOLUME IV

NUMBER 8

EDITORIAL:

Money in Radio Gadgets.....Hugo Gernsback 457

NEW DEVELOPMENTS IN RADIO:

How to Build the "Amplitenna" Capacity Aerial
R. D. Washburne and F. R. Harris 458
The Latest Radio Equipment..... 462
The International "Kadette"..... 464

SERVICE MEN'S DEPARTMENT:

Sleuthing for Static.....Glenn H. Browning 468
Building the Supreme "56" Point-to-Point Resistance Tester
Charles Pepin-Donat 470
The A.C. Meterless Tube Tester.....Sol. D. Prensly 472
Cartoon Advertising for the Radio Service Man
Fred E. Kunkel 474
Making Money With P.A. Systems.....Hubert L. Short 477
Operating Notes..... 479

Radio Service Data Sheets:

No. 83 Zenith Models 430 and 440, 12-Tube Superheterodyne 480
No. 84 Crosley "Chief" 12-Tube, Model 132-1 481
The Service Man's Forum..... 482
Short Cuts in Radio Service 483

TECHNICAL RADIO TOPICS:

An Experimenter's Long-Wave Tuner Chassis.....Samuel Whisk 461
Some Interesting Loudspeaker Facts—Part III
Eli M. Lurie 466
Controlling Fidelity with the 58 Tube.....Edgar Messing 476
Building a 7½-Watt, Battery-Operated, P.A. System
Louis Gancher 478
The Radio Craftsman's Page..... 484
Radio-Craft Kinks..... 485
Information Bureau..... 488
Quasi-Optical Home Experiments.....John B. Brennan, Jr. 504
Tube Characteristics.....Francisco Pinto Basto 512A

IN OUR NEXT FEW ISSUES:

A 2-TUBE SUPERHETERODYNE. Receivers are getting smaller and smaller, but the 2-Tube Superheterodyne to be described, which operates a loudspeaker and is built in a very unique box "takes the cake." Besides, it operates on either A.C. or D.C. without switching arrangements.

NEW TUBE ANNOUNCEMENTS. The tube field does not seem to be saturated as yet. Manufacturers are making smaller and better tubes for the Service Man. This Tube Department should be followed very closely for the latest tube information.

AUTOMOTIVE ANTENNAS. The December number of RADIO-CRAFT had an intermediate-frequency chart; our January number had a manufacturers' trade name and model number chart, but wait until you see the information we have compiled for you boys who are interested in automotive work. It is positively astounding!

RADIO-CRAFT is published monthly, on the fifth of the month preceding that of date; its subscription price is \$2.50 per year. (In Canada and foreign countries, \$3.00 a year to cover additional postage.) Entered at the post office at Mt. Morris, Ill., as second-class matter under the act of March 3, 1879. Trademark and copyright by permission of Gernsback Publications, Inc., 98 Park Place, N. Y. C. Text and illustrations of this magazine are copyright and must not be reproduced without permission of the copyright owners. We are also agents for WONDER STORIES and WONDER STORIES QUARTERLY. Subscription to these magazines may be taken in combination with RADIO-CRAFT at reduced Club rates. Write for information.
Copyright 1933. GERNSBACK PUBLICATIONS, INC.

HUGO GERNSBACK, President
S. GERNSBACK, Treasurer

J. M. HERZBERG, Vice-President
I. S. MANHEIMER, Secretary

Published by TECHNI-CRAFT PUBLISHING CORPORATION. Publication office: 404 N. Wesley Ave., Mount Morris, Illinois. Editorial and Advertising Office: 96-98 Park Place, New York City. Chicago Advertising Office: 737 North Michigan Avenue, Chicago, Ill. Western Advertising Office: 220 No. Catalina St., Los Angeles, Calif. L. F. McClure, Chicago Advertising Representative. Loyd B. Chappell, Western Advertising Representative.

London Agent: Hachette & Cie., 3 La Belle Sauvage, Ludgate Hill, E.C. 4
Paris Agent: Hachette & Cie., 111 Rue Reaumur
Australian Agent: McGill's Agency
179 Elizabeth St., Melbourne

NO, YOU'RE WRONG, we're NOT advertising Movies!

Paramount Pictures merely loaned us this photo of glamorous Marlene Dietrich as "The Blonde Venus" to help us make a point about radio reception to you.

You like Marlene because of her dramatic ability, her loveliness of face and form, and the rich warmth of her throaty voice—but even more fascinating is her different, intriguing *foreign-ness*.

If thoughts of foreign lands and foreign tongues lure you—if you would thrill to Grand Opera direct from La Scala Theatre in Milan or a tango Orchestra direct from Madrid—if you would like to send your ears world-roving . . . you can—at the twirl of a dial.

There is no need—NOW—to be bored by the eternal sameness of your local programs—the same orchestras—the "too-well-known" features that sometimes cause you to turn off your set.

For, AT LAST, there is one radio receiver that makes your cozy home a front row seat at the whole world's daily radio performances . . . not just the portion that is broadcast here in the states, but all the fascinating radio entertainment from England, France, Germany, Italy, Spain, and even far-off Australia.

With this one set, that is not merely a promise . . . it is a GUARANTEE of daily world wide radio reception . . . for the SCOTT ALL-WAVE DELUXE alone gives such a warranty. And every part of this precision-built, custom-constructed receiver (except tubes) is guaranteed for five years, instead of the ordinary 90 day period.

The SCOTT ALL-WAVE DELUXE is a combination short wave and long wave receiver. With it you will receive U. S. broadcasts from every State in the Union with a color of tone—a new depth of resonance—that will fill your home with a soul stirring wave of tone realism such as you never before have heard in a radio receiver.

You might think so superbly performing an instrument prohibitively high priced. Not at all! Although its quality is above all other radios—its cost is but little more than that of the ordinary receiver.

The coupon at the right below is for your convenience. Use it to get the whole thrilling story of this, the world's finest radio receiver.

E. H. SCOTT RADIO LABORATORIES, INC.

4450 Ravenswood Avenue Dept. C-23 Chicago, Ill.

THE Scott ALL-WAVE Deluxe



E. H. SCOTT RADIO LABORATORIES, INC.,
4450 Ravenswood Ave., Dept. C-23
Chicago, Ill.

Send me your two new brochures that tell how and why SCOTT ALL-WAVE DELUXE Receivers out-perform all others. This is not to obligate me in any respect.

Name

Address

Town State



Broadcasting Stations employ trained men continually for jobs paying up to \$5,000 a year.



Police Departments are finding Radio a great aid in their work. Many good jobs have been made in this new field.

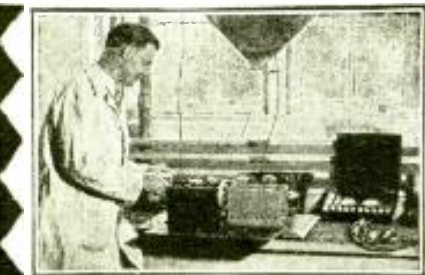

Spare time set servicing pays many N.R.I. men \$200 to \$1,000 a year. Full time men make as much as \$65, \$75, \$100 a week.

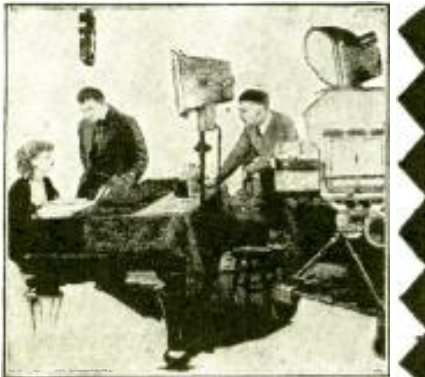

Talking Movies—an invention made possible by Radio—employs many well trained radio men for jobs paying \$75 to \$200 a week.



Television—the coming field of many great opportunities—is covered by my course.

I WILL TRAIN YOU AT HOME

Many Make \$50 to \$100 a Week in Radio-- *the Field With a Future*

My book, "Rich Rewards in Radio," gives you full information on the opportunities in Radio and explains how I can train you quickly to become a Radio Expert through my practical Home Study training. It is free. Clip and mail the coupon NOW. Radio's amazing growth has made hundreds of fine jobs which pay \$50, \$60, \$75, and \$100 a week. Many of these jobs may quickly lead to salaries as high as \$125, \$150, and \$200 a week.

Radio—the Field With a Future

Ever so often a new business is started in this country. You have seen how the men and young men who got into the automobile, motion picture, and other industries when they were started had the first chance at the big jobs—the \$5,000, \$10,000, and \$15,000 a year jobs. Radio offers the same chance that made men rich in those businesses. It has already made many men independent and will make many more wealthy in the future. You will be kicking yourself if you pass up this once-in-a-lifetime opportunity for financial independence.

Many Radio Experts Make \$50 to \$100 a Week

In the short space of a few years 300,000 Radio jobs have been created, and thousands more will be made by its future development. Men with the right training—the kind of training I will give you in the N.R.I. Course—have stepped into Radio at 2 and 3 times their former salaries. Experienced service men as well as beginners praise N.R.I. training for what it has done for them.

Many Make \$5, \$10, \$15 a Week Extra In Spare Time Almost At Once

My Course is world-famous as the one "that pays for itself." The day you enroll I send you material, which you should master quickly for doing 28 Radio jobs common in most every neighborhood. Throughout your Course I will show you how to do other repair and service jobs on the side for extra money. I will not only show you how to do the jobs but how to get them. I'll give you the plans and ideas that have made \$200 to \$1,000 a year for N.R.I. men in their spare time. G. W. Page, 110 Raleigh Apts., Nashville, Tenn., writes: "I made \$935 in my spare time while taking your Course." My book, "Rich Rewards in Radio," gives many letters from students who earned four, five, and six times their tuition fees before they graduated.

Get Ready Now for Jobs Like These

Broadcasting stations use engineers, operators, station managers and pay up to \$5,000 a year. Radio manufacturers employ testers, inspectors, foremen, engineers, service men, buyers, and managers for jobs paying up to \$6,000 a year. Radio dealers and jobbers (there are over 35,000) employ service men, salesmen, buyers, managers and pay up to \$100 a week. Talking pictures pay as much as \$75 to \$200 a week to men with Radio training. There are hundreds of opportunities for you to have a spare time or full time Radio business of your own—to be your own boss. I'll show you how to start your own business with practically no capital—how to do it on money made in spare time while learning. My book tells you of other opportunities. Be sure to get it at once. Just clip and mail the coupon.

I HAVE STARTED MANY IN RADIO AT 2 AND 3 TIMES



**\$400.00
Each
Month**

"I spent fifteen years as traveling salesman and was making good money but could see the opportunities in Radio. Believe me, I am not sorry, for I have made more money than ever before. I have made more than \$100 each month and it really was your course that brought me to this. I can't say too much for N.R.I."—J. G. Dahlestad, Radio Sta. KYA, San Francisco, Cal.



**\$800.00
In Spare
Time**

"Money could not pay for what I got out of your course. I did not know a single thing about Radio before I enrolled, but I have made \$800 in my spare time although my work keeps me away from home from 6:00 A.M. to 7:00 P.M. Every word I ever read about your course I have found true."—Milton I. Leiby, Jr., Topton, Pennsylvania.



**Chief
Engineer
Station WOS**

"I have a nice position and am getting a good salary as Chief Engineer of Radio Station WOS. Before entering Radio, my salary was barely \$1,000.00 a year. It is now \$2,400.00 a year. Before entering Radio, my work was, more or less, a drudgery—it is now a pleasure. All of this is the result of the N.R.I. training and study. You got me my first important position."—H. H. Lane, Radio Station WOS, Jefferson City, Missouri.

TO BE A RADIO EXPERT

Act Now --- Mail Coupon Below for Free Book of Facts and Proof

You Learn at Home in Your Spare Time to be a Radio Expert

Hold your job. There is no need for you to leave home. I will train you quickly and inexpensively during your spare time. You don't have to be a high school or college graduate. My Course is written in a clear, interesting style that most anyone can grasp. I give you practical experience under my 50-50 method of training—one-half from lesson books and one-half from practical experiments with equipment given without extra charge. This unique and unequalled method has been called one of the greatest developments in correspondence Radio training. N.R.I. pioneered and developed it. It makes learning at home easy, fascinating, practical.

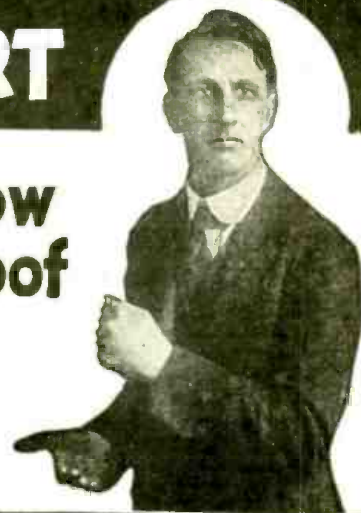

Special FREE Offer

Learn the Secrets of Short Wave, Television, Talking Pictures, Set Servicing, Broadcasting, etc.

I'll give you more training than you need to get a job—I'll give you your choice, and not charge you extra either, of my Advanced Courses on these subjects—(1) Television, (2) Set Servicing and Merchandising, (3) Sound Pictures and Public Address Systems, (4) Broadcasting, Commercial and Ship Radio Stations, (5) Aircraft Radio. Advanced specialized training like this gives you a decided advantage.

Your Money Back if You are Not Satisfied

I will give you an agreement in writing, legal and binding upon this Institute, to refund every penny of your money upon completing my Course if you are not satisfied with my Lessons and Instruction Service. The resources of the National Radio Institute, Pioneer and World's Largest Home-Study Radio School stands behind this agreement.

Find Out What Radio Offers. Get My Book

One copy of my valuable 64-page book, "Rich Rewards in Radio," is free to any resident of the U. S. and Canada over 15 years old. It has started hundreds of men and young men on the road to better jobs and a bright future. It has shown hundreds of men who were in blind alley jobs, how to get into easier, more fascinating, better paying work. It tells you where the good Radio jobs are, what they pay, how you can quickly and easily fit yourself to be a Radio Expert. The Coupon will bring you a copy free. Send it at once. Your request does not obligate you in any way. ACT NOW.

J. E. SMITH, President
Dept. 3BX, National Radio Institute
Washington, D. C.

FORMER PAY



Experienced
Radio Man
Praises
N. R. I.
Course

"Before taking your course, I had worked at Radio for over seven years, doing quite a bit of servicing, but I realized that I was in need of better training. From the first lesson on I began to understand points that had me wondering. The course has taught me what I could not have learned otherwise and I would not take many times the price it has cost me, for the knowledge I have gained. In a period of nine months I have made at least \$3,500."—C. J. Stegner, 23 So. Sandusky St., Delaware, Ohio.

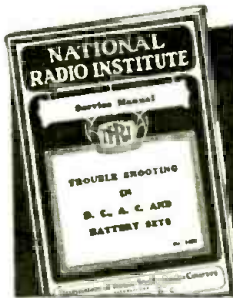
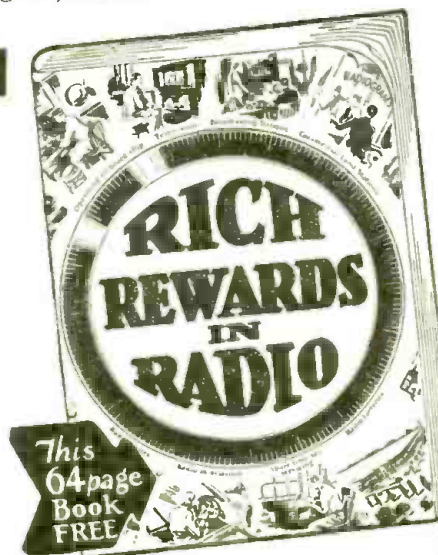

Act now and receive in addition to my big free book "Rich Rewards in Radio," this Service Manual on D. C., A. C., and Battery Operated sets. Only my students could have this book in the past. Now readers of this magazine will receive it free. Overcoming hum, noises of all kinds, fading signals, broad tuning, howls and oscillations, poor distance reception, distorted or muffled signals, poor Audio and Radio Frequency amplification and other vital service information is contained in it. Get a free copy by mailing the coupon below. ACT NOW.

SPECIAL Radio Equipment for Broad Practical Experience Given Without Extra Charge



My Course is not all theory. I'll show you how to use my special Radio equipment for conducting experiments and building circuits which illustrate important principles used in such well-known sets as Westinghouse, General Electric, Philco, R. C. A., Victor, Majestic, and others. You work out with your own hands many of the things you read in our lesson books. This 50-50 method of training makes learning at home easy, interesting, fascinating, intensely practical.

Clip and mail NOW for FREE INFORMATION

J. E. SMITH, President
National Radio Institute, Dept. 3BX
Washington, D. C.

Dear Mr. Smith: I want to take advantage of your Special Offer. Send me your manual "Trouble Shooting in D.C., A.C. and Battery Sets" and your book "Rich Rewards in Radio," which explains Radio's Opportunities for bigger pay and your method of training men at home in spare time. I understand this request does not obligate me.

Name

Address

City..... State.....

"M"

5. **CLAROSTAT CONTROL HANDBOOK.** A large 32-page book containing detailed specifications of volume controls, attenuators, constant-impedance controls, phonograph pickup faders, tone controls, line ballasts, rheostats, potentiometers and fixed resistors of various kinds, together with valuable circuit-design data. Contains many diagrams and charts, and a guide of replacement volume and tone controls for many commercial receivers. *Clarostat Manufacturing Company, Inc.*

6. **MEASURING RESISTANCE BY THE DEFLECTION METHOD.** The conventional method for the measurement of resistance involves the use of the Wheatstone bridge, a costly piece of apparatus. However, there are other methods which provide a fair degree of accuracy, enough for all practical purposes. The least expensive is the deflection method, which makes use of popularly priced milliammeters and fixed resistances. This bulletin describes the method completely, and should be very useful to Service Men and experimenters with limited meter equipment. *Shalleross Manufacturing Company.*

8. **ELECTRAD PRODUCTS.** Descriptions of the full line of Electrad volume controls, voltage dividers, vitreous resistors, Truvolt adjustable resistors, amplifiers and other devices for radio and electrical applications. Among other diagrams, it includes twenty-four circuits showing the placement of volume controls in different types of broadcast receivers. *Electrad, Inc.*

11. **SUPREME INSTRUMENTS.** Contains lengthy descriptions of the Supreme service instruments, including the AAA1 Diagonometer, which is five instruments in one, the model 90 analyzer, the model 40 tube tester and the models 60 and 70 oscillators. Interesting to the Service Man because it tells how his work is facilitated by ingeniously-designed test equipment that indicates the condition of an entire set in a few minutes. New test apparatus to take care of the new tubes is also described. *Supreme Instrument Corporation.*

14. **STANDARD RESISTOR COLOR CODE.** This handy little card, measuring three by five inches, should be in every Service Man's kit. It illustrates and explains the standard R.M.A. method of marking fixed resistances with different combinations of colors to indicate the resistance value in ohms. It will save a lot of confusion in the field, as most resistors are now marked only by color, and do not bear figures at all. *Lynch Manufacturing Company, Inc.*

19. **A BAPTISM OF FIRE.** Centralab fixed resistors are made by forcing a carefully calibrated resistance material through a plastic ceramic material, and then baking both under terrific heat. This booklet describes the manufacturing process in detail, and lists the advantages claimed for fixed resistors of this type. It is interestingly written and illustrated, and makes good reading. *Central Radio Laboratories, Inc.*

21. **READRITE RADIO INSTRUMENTS.** This sixteen-page pamphlet contains some valuable hints on the testing of electrolytic condensers, as well as descriptions of the full line of popular-priced Readrite instruments. Worth having. *Readrite Meter Works.*

22. **HOW TO TEST PENTODES.** This is a reprint of an article of the same name that appeared in the September, 1931, number of RADIO-CRAFT, accompanied by descriptive matter on the adapters specified for the purpose. If you missed the original article study the reprint; it contains much useful data for owners of testers or analyzers not already equipped to test pentodes. *Alden Manufacturing Company.*

27. **DUBILIER CONDENSERS.** The name Dubilier being synonymous with condensers in the minds of many people, the latest catalog of Dubilier condensers is sure to be of interest to all classes of radio users. This 16-page booklet describes the entire line of receiving condensers and tells something of the historical background of the company. The special service kit and replacement units are recommended to the attention of Service Men. Included with the catalog is an instructive technical article dealing with electrolytic condensers. *Dubilier Condenser Corporation.*

28. **HAMMARLUND PRECISION PRODUCTS.** Midget variable condensers and their numerous applications in short-wave and broadcast receivers are discussed in a folder accompanying the complete catalog of Hammarlund variable condensers and coils. Some excellent circuit kinks are given. The catalog contains dimensional drawings of the popular Hammarlund midgets which may be of assistance to constructors designing small receivers. *Hammarlund Manufacturing Company, Inc.*

55. **PHILCO PARTS CATALOG.** This new catalog will undoubtedly be of great help to all radio Service Men because it contains the only official, complete list of the more common replacement parts used in every Philco receiver from the very beginning of the company to the present

time. The manufacturers are anxious to cooperate with Service Men and offer this catalog to all who want it. *Philco Radio & Television Corp.*

63. **THE AKAFORMER.** The Akaformer, described in this folder, is a coupling device that hooks right on to the aerial wire, and connects to the set through a shielded down lead. The combination tends to reduce noise in the set picked up by the usual lead in, which, running along the side of the building, is more readily affected by elevator motors, vacuum cleaners, dentists' drills and other electrical machinery than the flat top section of the aerial proper. The device is inexpensive and is easily installed, and is thereby a very profitable item for Service Men located in districts where artificial noise is very troublesome. *Amy, Aceves & King, Inc.*

64. **SYLVANIA RADIO TUBES.** So many new tubes have appeared during the past several months that tube charts printed as recently as the Spring are incomplete and therefore of little value for reference purposes. Readers desiring new and complete charts for their shop will find the new Sylvania chart very desirable. It measures 11 by 17 inches when unfolded and shows bottom views of the tube bases in addition to full average characteristics of old tubes dating back to the 199 and 200A and all the new tubes including the latest 6.3 and 2.5 volt types. Special mention is made of the 56, 57, 58, 46 and 82 tubes; complete data are also given on the 38, 41, 69, 42 and 44. *Hygrade Sylvania Corporation.*

66. **WHOLESALE RADIO SERVICE CATALOG.** The 1932 Spring and Summer Radio Catalog of the Wholesale Radio Service Company is the kind of catalog the radio Service Man and experimenter will carry around with him all the time in his back pocket. Measuring 7 by 10 1/4 inches and containing 100 pages, it is one of the most complete catalogs we have ever seen. It includes everything from soldering lugs to all-wave combinations, and is of particular value to the Service Man because of its handy lists of replacement parts for standard receivers. *Wholesale Radio Service Company, Inc.*

76. **THE COAST-TO-COAST "BROADCAST."** The "Broadcast" is the Fall 1932 edition of a 100-page mail order catalog that is a veritable encyclopedia. Its listings are very varied, and run from soldering lugs to complete 100-watt public address amplifiers. Every article is well illustrated and described for the benefit of radio dealers and Service Men, for whom the volume is specifically intended.

A large amount of space is also given to replacement power transformers, condensers and resistors for ordinary service work. This catalog is well prepared and is worth saving. *Coast-to-Coast Radio Corporation.*

80. **FLECHTHEIM CONDENSERS.** A wide variety of fixed condensers, ranging from tiny midgets, the size of postage stamps, to heavy transmitting units a foot high, are described and illustrated in the latest Flechtheim catalog. This is very useful for reference in design and service work, as it gives the mechanical dimensions and electrical characteristics of all models in minute detail. *A. M. Flechtheim & Co.*

81. **I. R. C. RESISTOR CATALOG.** This sixteen-page catalog describes a very complete line of fixed resistors for radio purposes. It includes full performance characteristics, so that a Service Man or an experimenter with a particular requirement in mind can select exactly the right unit for his purpose. A section in the back contains valuable data on the conversion of milliammeters into ohmmeters and voltmeters, and on the extension of voltmeter and ammeter ranges. This catalog is well worth saving. *International Resistance Company.*

86. **YAXLEY AND ELKON CATALOGS.** The Yaxley catalog is valuable for the Service Man because it lists numerous rheostats, potentiometers, volume controls, replacement controls and resistances for service work. Detailed dimension drawings are included; this feature will be appreciated by every Service Man who has been called on to install replacement units in cramped receivers. Two pages of volume control replacement information are included, along with fourteen diagrams showing different circuit positions for such controls.

The Elkon catalog is devoted exclusively to dry electrolytic high voltage condensers for filter and bypass purposes. It also includes valuable replacement data on commercial receivers. *P. R. Mallory & Co.*

89. **MICROPHONES.** A complete line of microphones and accessories for amateur, public address and broadcast station use is described and illustrated in a handy four-page pamphlet. The "mikes" range from small hand units to large condenser models containing two stages of amplification. *Sound Engineering Corporation.*

91. **SAMSON MIK-2.** About five years ago the Samson company brought out the first completely A.C. operated microphone amplifier, known as the MIK-1. The new MIK-2, described in this bulletin, replaces the MIK-1 and adds many features. It is made in two units, a mixer-amplifier and a power supply, and will supply excitation current to, and take the output from, one to three double button microphones. *Samson Electric Company.*

92. **TWO BOOKS FOR A COMPLETE RADIO EDUCATION.** The books described in this circular are "Radio Physics Course," by Alfred A. Ghirardi, and "Radio Servicing Course," by Ghirardi and Bertram M. Freed, the latter a well known contributor to *Radio Craft*. The first is a complete radio education in itself, while the title of the second is self-explanatory. *Radio Technical Publishing Co.*

93. **DUBILIER CONDENSERS.** The 1933 catalog of Dubilier condensers is a large 16-page booklet describing fixed condensers for every conceivable application. These range from little mica units for receiving circuits to man-high assemblies for transmitting work. A useful catalog to all radio men. *Dubilier Condenser Corporation.*

READERS' BUREAU

On this page are listed manufacturers' catalogs and booklets, chosen because they are of interest to readers of RADIO-CRAFT. You can obtain copies FREE by using the coupon below.

RADIO-CRAFT 5-93

Readers Bureau
96-98 Park Place, New York, N. Y.

Please send me free of charge the following booklets indicated by number in the published list above:

No.

Name

Address

CityState.....

(Please check the following)

I am

(1) Service Man (2) Experimenter
 (3) Dealer (4) Jobber
 (5) Radio Engineer
 (6) Licensed Amateur
 (7) Professional or Amateur Set Builder

This coupon will not be honored unless you check off your classification above.

By buying direct—you pay only ONE Profit

Manufacturers cost determines selling prices rather than list prices—tube prices that mean more sales and greater profits. Net prices applied on all types, and as example, we list dealer's cost on all numbers.

Our sales policy: is first quality merchandise, rapid service, low price, and a square deal. All tubes are

- 1—GUARANTEED FIRST QUALITY.
- 2—R.C.A. LICENSED.
- 3—FULLY REPLACEABLE UNDER R.M.A. STANDARD POLICY.

4—UNIFORMLY WITHIN R.C.A. TEST LIMITS.

5—ATTRACTIVELY PACKED.

6—ARCO BRAND IS NOT SOLD BY MAIL ORDER HOUSES OR ANY OTHER MEDIUM OTHER THAN DIRECTLY BY US BY THIS METHOD.

COMPLETE STOCK READY FOR IMMEDIATE SHIPMENT

Order from this page—Remit 20% with order, balance C. O. D. All prices are F.O.B. FACTORY, Newark. Shipments go forward express or parcel post. No order for less than \$5.00 accepted.

TYPE	ANY QUANTITY
UX-201A	Amplifier or detector..... \$0.30
UX-226	AC amplifier..... .30
UY-227	AC amplifier or detector..... .30
UX-171	Same characteristics as 171A on tungsten filament, 1/2 amp..... .30
UX-171A	Power output amp. for AC or DC operation, 1/2 amp..... .30
UX-240	Designed for impedance and resistance coupling..... .40
UX-120	Power amp. used in last stage of audio freq..... .40
UX-199	Detector and amp. tube, long prongs..... .40
UV-199	Standard base, has a 201A base, same characteristics as 199..... .40
UX-199	Same characteristics as UX-199 only short prongs..... .40
UX-112A	Power amp. tube for low cur. consump., 1/2 amp..... .40
UX-112	Power Amp., 1/2 amp..... .40
UX-200A	Detector tube recommended for weak signals..... .40
UY-224	AC screen grid amplifier..... .40
UX-245	Power amplifier..... .40
UX-201B	1/2 Amp. Amplifier and Detector..... .60
UY-246	Power Amplifier..... .60
UY-247	Power Pentode..... .60
WD-11	Detector Amp..... .60
WD-12	Detector Amp..... .60
UX-230	Dry cell amp. and detector, 2 volts..... .60
UX-231	Dry cell amp.—last audio stage, 2 volts..... .60
UX-232	Dry cell screen grid amp., 2 volts..... .60
UY-233	Power Amplifier Pentode, 2 volts..... .85
UX-234	Screen Grid Pentode R. F. Amplifier..... .85
UY-235	Super control screen grid amp..... .60
UY-236	Screen Grid Radio Freq. Amp..... .60
UY-237	Detector Amplifier..... .85
UY-238	Power Amplifier Pentode..... .85
UY-239	DC R.F. Pentode Amplifier..... .85
UY-551	Variable Mu..... .60
41	Power Pentode..... .60
42	Power Pentode..... .60
55	Duo Diode Detector..... .60
56	A.F. and R.F. Amplifier and Oscillator..... .60
57	6 prong Screen Grid R.F. Amplifier and Detector..... .60
58	6 prong Variable Mu R.F. Amplifier and Super Detector..... .60
59	Power Amplifier..... .60
85	Duplex Diode Triode 6 prongs..... .60
89	Power Amplifier 6 prongs..... .60
UX-210	For power amplifier, high voltage..... 1.10
UX-222	Screen grid radio frequency amp..... 1.10
UX-250	Power amp. used in last stage of audio freq..... 1.10
	Ballast tube to prevent tubes in set from blowing out..... 1.10
	Special super-sensitive Audio Freq. 201A..... .60
	Special super-sensitive Radio Freq. 201A..... .60
	Special 171 AC 1/2 amp. extra coated filament—good for electric sets..... .60
	T-14 (201A) High Mu high emission..... .60
	Switch tube, 201A or 112 or 171 double life..... .60
	Adapter tube 226, 227, 171A, to convert lat. set. to AC, each..... .60
UY-227A	AC amplifier or detector, same as 227 but quick heater..... .60
UY-224A	AC screen grid amplifier, same as 224 (but quick heater)..... .60
UX-182	Sparton Type..... .85
UX-183	Sparton Type..... .85
UX-484	Sparton Type..... .85
UX-585	Sparton Type (Power tube)..... 2.10
UY-686	Sparton Type..... .85
UX-401	Kellogg Type..... 1.50
UX-403	Kellogg Type..... 2.00

RECTIFIER AND CHARGER BULBS

125 Mil. rectifying tube (B. II.) (Raytheon Type).....	1.25
6/10 amp. triode charger bulb (Tungar Type).....	2.00
2 amp. old and new type charger bulbs (list \$4.00) (Tungar Type).....	2.00
5 and 6 amp. charger bulbs (list \$8.00) (Tungar Type).....	3.75
15 amp. charger bulbs (Tungar Type).....	7.50
UX-866	Hot Cathode Mercury Vapor Half-Wave Rectifier (Heavy Duty)..... 2.75
UX-280M	Hot Cathode Mercury Vapor Full-Wave Rectifier same as UX-588..... 1.10
UX-281M	Hot Cathode Mercury Vapor Half-Wave Rectifier..... 1.90
UX-871	Hot Cathode Mercury Vapor Rectifier..... 1.10
UX-280	Full-Wave Rectifier for High Emission..... .40
UX-281	Half-Wave Rectifier..... 1.10
UX-282	Full-Wave Mercury Vapor Rectifier..... 1.10
UX-283	Rectifier..... .85
UX-216B	Half-Wave Rectifier..... .85
UX-213	Full-Wave Rectifier..... .40

PHOTO CELLS

Photoelectric cell, "Potassium" Type O.....	2.10
Photoelectric cell, "Caesium" Type A 4 1/2" overall length.....	7.90
Photoelectric cell, "Caesium" Type R, 3 1/16" overall length.....	5.90
Photoelectric cell, "Caesium" Type T, Same as UX-808.....	5.90

TELEVISION TUBES

Telion Reflectron Neon Television Tube, 1" Cathode Square Type C.....	3.85
Telion Neon Television Tube, 1 1/2" Cathode Square Type V.....	3.85
Telion Neon Television Tube, 1" Cathode Square Type X.....	2.10

TRANSMITTING TUBES

7 1/2 Watt—A-565	Screen Grid Amplifier.....	\$12.25
15 Watt—A-210-C	Oscillator and Amplifier.....	2.55
50 Watt—A-511	General Purpose.....	11.00
50 Watt—A-511-C	General Purpose.....	11.00
50 Watt—A-203-A	Oscillator and Amplifier.....	11.00
50 Watt—A-203-C	Oscillator and Amplifier.....	11.00
50 Watt—A-845	Amplifier and Modulator.....	11.00
50 Watt—A-845-C	Amplifier and Modulator.....	11.00
7 1/2 Watt—A-852	Oscillator and Amplifier.....	15.00
7 1/2 Watt—A-860	Screen Grid and Amplifier.....	20.00
50 Watt—A-861	Oscillator and Amplifier.....	15.00

The above type numbers are interchangeable with similar type numbers.



Television Tube
1 1/2" Cathode
Type V

\$3.85



Potassium
Photo Cell
Type O

\$2.10



Caesium Photo Cell
Latest development
responding instantaneously
to all light impulses. 4 1/2" overall
Type A

\$7.90



50-watt Transmitter
Tube
Type 203A

\$11.00

REFLECTRON



Reflectron
Improved Television
Receiver Tube
Type C

\$3.85

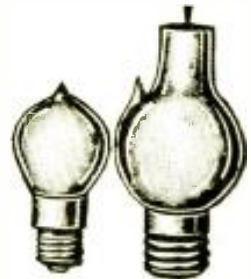

Charger Bulb
"Tungar" Type

6/10 Amp..... \$2.00
2 Amp. (old or
new type)..... 2.00
5 and 6 Amp..... 3.75
15 Amp..... 7.50

DISCOUNTS:

Additional tubes for the amount of 20% of your order given FREE as BONUS. You may select either UY-227 or UX-245 tubes in our bonus offer. By taking advantage of our liberal discount, it will bring the price of tubes to a considerable low figure.

This Special Tube Offer Expires February 15, 1933

ARCO TUBE COMPANY, 40 PARK PLACE, NEWARK, N. J.



Courtesy of the National Broadcasting Company

WHAT YOU NEED TO S U C C E E D I N R A D I O

RADIO is a highly specialized business. As it develops it is becoming more exacting in its demands. But radio is the modern field of opportunity for those who keep step with its progress and pioneer in its opportunities!

There is a great need for *trained* men in the radio industry. There is no place for *untrained* men. Experience must be accompanied by technical knowledge.

A pioneer in home study, the International Correspondence Schools have kept apace of the times and offer courses prepared by authorities, which give practical instruction in fundamentals and latest developments alike. The courses are revised regularly.

Composed of 24 basic divisions, the Complete Radio Course is designed to give thorough instruction in the whole field of radio. The I. C. S. Radio Servicing Course was prepared specially for men who wish to become service experts. Study of it makes possible leadership over competition. The I. C. S. Radio Operating Course is vital to mastery of operating and transmitting.

We will be pleased to send you details of any or all of these subjects. Just mark and mail the coupon—the information will be forwarded without delay. Why not do it today—*now!*

INTERNATIONAL CORRESPONDENCE SCHOOLS

BOX 6678, SCRANTON, PA.

Without cost or obligation, please tell me all about the NEW RADIO COURSE

Name _____ Age _____

Street Address _____

City _____ State _____

If you reside in Canada, send this coupon to the International Correspondence Schools Canadian, Ltd., Montreal, Canada



"Takes the Resistance Out of Radio"

Editorial Offices: 96-98 Park Place, New York, N. Y.

HUGO GERNSBACK, Editor

Vol. IV, No. 8, February, 1933

MONEY IN RADIO GADGETS

An Editorial by HUGO GERNSBACK

THE dictionary does not define the word "gadget." It is supposed to be a mechanical appliance or accessory, which may, or may not, be a necessity.

The radio industry is turning out an increasing number of such gadgets, and many of them have acquired a wide sale; a number of them may even be termed necessities. It all depends upon the point of view, because frequently a gadget may become an important radio accessory. These gadgets are of importance, today, because they give new outlets both to those branches of the radio manufacturing industry that are equipped to turn out such devices, and to the radio Service Man who installs them.

These gadgets are important, and should be taken most seriously by the radio trade because anything that enhances the radio owner's interest in his set is, after all, important. When a radio owner has a radio set in his home which he does not use, he becomes a direct loss to the entire industry. Give him something to either amuse himself, amuse his children, or get better radio reception through the means of his radio set, and immediately that man becomes again a live asset to the industry.

It is surprising how little attention the radio industry has paid to the toy radio gadget. I was, perhaps, the first one to point this out in an article published in one of my radio magazines in 1925. This particular article of mine showed how, by means of a loudspeaker arrangement, dolls with wire feet were made to dance on a large diaphragm. The loudspeaker unit, of course, was plugged into the radio set, and the dolls danced in unison with the vibrations of the 6-inch diaphragm.

Few engineers and few experimenters seem to understand that every radio set actually generates a small amount of power on its output side. Some manufacturers have already recognized how this power can be utilized, and are now putting out a number of radio toys. A recent example came to my attention where a papier mâché dog would wag its tongue when connected to the output side of the radio set. Another novelty, which is gaining vast popularity, is not plugged into the radio set, but works by means of a small microphone placed in front of a radio. This particular toy is a dancer which dances a jig to the tune of the sound vibrations issuing from the loudspeaker, transmitted to the little microphone, which in turn energizes a number of relays; this operates the dancer.

The possibilities in this particular line are, of course, tremendous; and during the next two years we will see a veritable avalanche of such toys, instructive and otherwise. I predict that an entirely new branch of radio will be created in this particular field.

Then we have other types of gadgets. Right now, there seems to be a small boom in miniature microphones, which are connected to the detector of your radio set. You are then supposed to broadcast from a concealed point to your friends, giving all sorts of amusing fake announcements over your own radio without benefit of the broadcast station. It is said to be an excellent entertainer. On good authority, it is understood that close to half a million of

these little microphones will be sold during this year.

Then, we have the "radio" clock, a most useful gadget. In my home, such a radio clock promptly turns on the radio at a pre-determined hour every morning, and I am awakened by radio unfailingly, and better than could be done by means of a plain alarm clock. Your ears become used to an alarm clock so that after a while you no longer hear it. But the radio program, every morning, is different. It may be talk or music, or what not. There are a number of excellent clocks of this kind on the market, and they make valuable adjuncts to any man's radio set.

Next on the list are remote control attachments that make it possible for you to sit in a chair at the other end of the room, tune your radio and control the volume all from the same gadget. While these remote control outfits have not revolutionized the business during the past few years, the reason probably was that the price was too high. A low-priced remote control gadget would certainly prove a good seller.

Then, we have a host of new trick aeriels which have been flooding the market in the past few years. Many of these have been out and out fakes, which every radio man would immediately spot. There are, however, a number of notable exceptions.

High gain sets, for instance, do not need outdoor antennas in all cases. Some recent gadgets are intended to be placed underneath your home telephone receiver, the idea here is that we have an insulated plate upon which the telephone is placed. This plate goes to the aerial binding post of your set. The plate being insulated, gives a condenser action to the bottom of the telephone set, and it makes a fair interior antenna. It suffers from the disadvantage that every time you lift up the telephone receiver you get a loud and noisy click in your set.

More important and vastly better, are new shield leads for outdoor antennas, very much in vogue now. These are supposed to eliminate the usual man-made static, and by means of a small transformer attached to the upper part of the antenna, they actually succeed in cutting down a great deal of man-made static. This particular type is used for broadcast waves.

Another type, whereby the aerial is transposed, by means of transposition blocks, is especially adapted for short waves, and in actual practice is most efficient.

All of these devices are interesting, particularly to the Service Man, and those who have to make a living from radio merchandise.

Radio Service Men should be particularly interested in all such new devices because they mean a new source of income which becomes increasingly important as time goes by. There are many reasons why radio set owners become dissatisfied with their radio sets, and it is always a good idea to rekindle their interest by means of new devices. Incidentally, the profit on these gadgets is as great as the profit on other important accessories. Frequently, extraordinary good sales are reported by various Service Men who have gone into this branch of radio.

HOW TO MAKE THE "AMPLITENNA" CAPACITY AERIAL

R. D. WASHBURNE and F. R. HARRIS

ALADDIN, in his heyday, never conjured the magic inherent in the "Amplitenna" illustrated in Fig. A, which makes weak sets strong and strong sets stronger!

This new radio instrument, an inexpensive little box which measures only 7x12x5 ins. (approximately), includes a high-gain, variable-mu pentode aperiodic R.F. amplifier, complete with power pack, and a non-directional "capacity antenna," (as shown in the schematic circuit, Fig. 1). It is connected to any radio set by means of a highly efficient shielded "lead-in" and acts as an "amplifying antenna."

This device is so sensitive that in many instances much better results can be obtained with it *indoors*, than can be obtained with an ordinary aerial *outdoors*! For instance, the writers were able to hear only *one* station between 90 and 100 on the dial of a good screen-grid set located in the laboratory at Newark, N. J., whereas, when the set was switched from the regular outdoor antenna to the indoor "self-powered amplifying antenna," *seven* stations were heard with good loudspeaker reception! (Six hundred per cent more stations!)

But let us start at the beginning, and find out just what is what con-

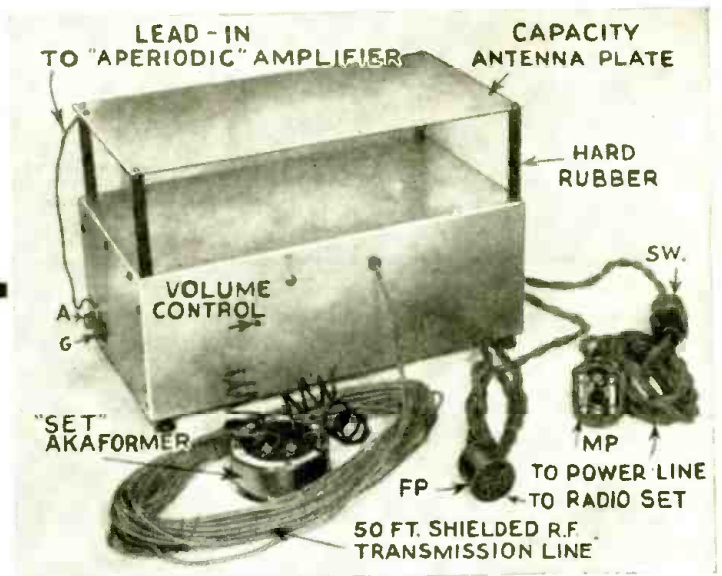

Fig. A
The "amplitenna," comprising: (a) a capacitive antenna; (b) a high-gain untuned R.F. amplifier, complete with power supply; and (c) a shielded R.F. transmission line.

cerning this new radio instrument. At the outset, we list some of the present applications of this powerful, untuned amplifier, as follows:

- (1) High-gain antenna;
- (2) DX booster unit;
- (3) Multiple-receiver antenna system amplifier;
- (4) Automotive-radio antenna-plate;
- (5) Interference locator;
- (6) Foundation unit for T.R.F. receiver.

In order that the constructor may have a better working knowledge of the factors involved in the design of this device, it is necessary that each step in its development be closely noted; thus, there will be less likelihood of a misstep in duplicating the instrument.

THIS NEW RADIO INSTRUMENT—

Replaces (inexpensively) the outdoor antenna, in suitable localities;

Used with an outdoor antenna, greatly increases the strength of all signals;

Plus a modern radio set, makes an excellent interference locator;

Connected in the antenna circuit of an old radio set, makes DX stations sound like locals;

In the laboratory, acts as a high-gain R.F. amplifier with a "mu" of about 15,000;

As an amplifier, remotely operated, for multiple-receiver installations, delivers sufficient power to operate several hundred radio sets;

In multiple-receiver installations, may eliminate the need for an elevated antenna;

In automotive radio installations, may be used in place of the "antenna-plate," with greatly increased sensitivity.

May be used as the "foundation" chassis of a T.R.F. receiver.

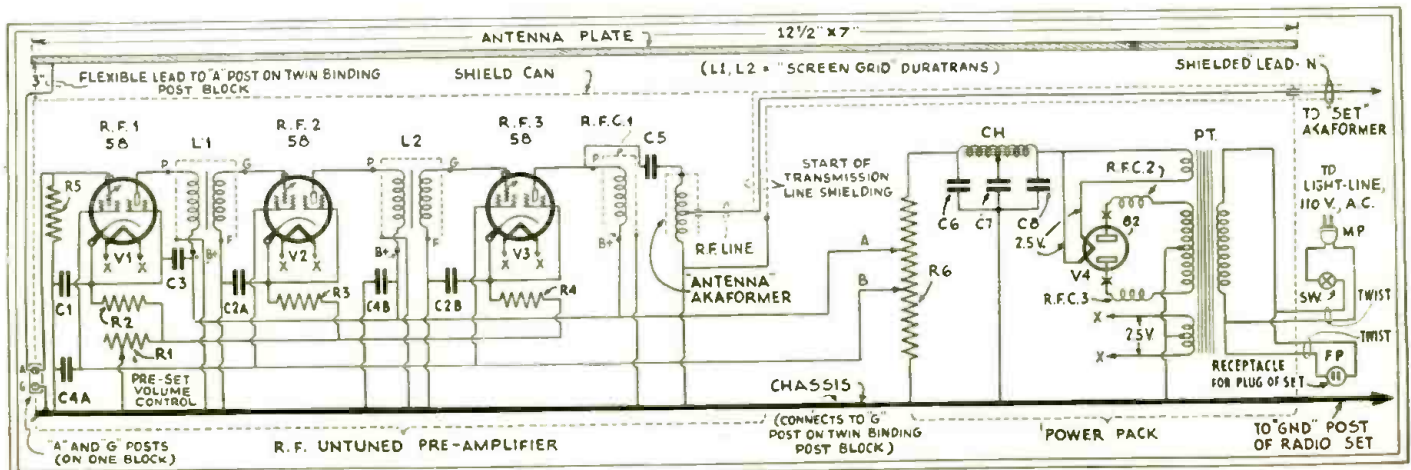

Fig. 1
Schematic circuit of the complete "amplitenna." The components determine the degree of amplification, shielding, and bypassing.

Non-T.R.F. Amplification

The first riddle concerned a means of amplifying all the broadcast frequencies (550 to 1,500 kc.) evenly, without the use of moving parts or expensive components.

Untuned R.F. amplification (using suitable iron-core R.F. transformers), meets the bill, for it has simplicity, absence of moving parts, extreme compactness, and low cost to recommend it. However, in direct contrast with the usual tuned R.F. amplifier (incorporating air-core R.F. transformers and a number of variable condensers), it has heretofore been deficient in the matter of gain-per-stage, necessitating one or two additional stages in obtaining a corresponding output. With the three-element tubes, this lowered degree of amplification has been considered a drawback, accounting, in part, for the greater popularity of the tuned R.F. amplifier. But now, with the advent of the five-element, or pentode, tubes, the necessary gain-per-stage may be attained in the correctly designed untuned R.F. amplifier.

(The "Durastran" iron-core R.F. transformers selected for this circuit cannot be duplicated by the amateur, with any degree of success, as the iron cores are made of special "radio frequency" iron laminations, only .002-in. thick, and insulated by a special process.)

Overall and Stage Gain

It is difficult to realize the impetus which the new tube designs can give to the use of untuned amplifiers, unless we can visualize the facts. Therefore, we reproduce in Fig. 2 a curve which illustrates the comparative results secured with old and new instrument designs. Each tube type is used at its normal rated current values.

First, we see the line which represents the old, or "ordinary," Durastran used in a stage incorporating the type '27, 3-element tube; the gain-per-stage is only about 5. Three such circuits in tandem result in an overall gain of only about 125! Next, we come to a similar circuit set-up incorporating the type '24, 4-element tube, and the "screen-grid" Durastran especially designed for use with it; the average gain has increased to about 13. For three stages the total voltage amplification would be about 2,000. Considerably greater improvement resulted with the advent of the type '34, variable-mu R.F. pentode; here

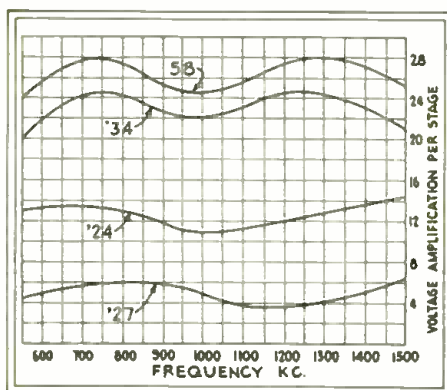

Fig. 2
Stage-gain characteristics of "Durastrans."

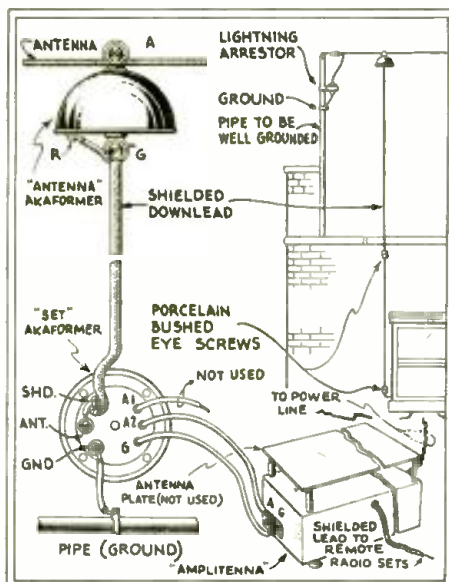

Fig. 3
The "amplitenna" used only as a remote amplifier in multiple-receiver installations.

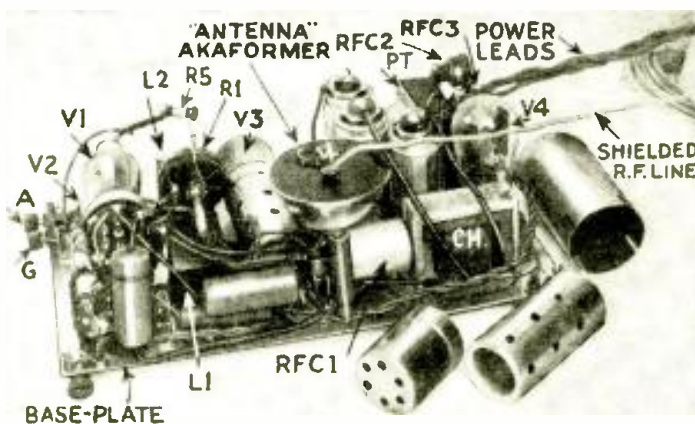

Fig. 8
Interior view of the "amplitenna," complete with power equipment, "ready to go."

the stage gain, still using the "screen-grid" Durastran, has increased to about 22. The overall amplification for three stages is now about 10,000. Finally, we incorporate the new type 58 variable-mu R.F. pentode, together with our "screen-grid" Durastran, in a stage which now shows a gain of about 26. For the three stages the gain is well over 15,000! It is this combination which was selected by the authors for the amplifier portion of the "power antenna." (Although the graph indicates a tendency toward "peaked" performance at two points in the tuning range, this effect was not observable in practice, by ear; the action seemed to be quite "flat." These tubes of the new "50" series—and the 82 rectifier—consume much less filament power than the next nearest types of older design.)

This is amplification enough to overcome all the losses involved in a circuit of this general nature, with sufficient amplification left over to make practical the original idea of using only a "capacity" or, more correctly, "capacitive" antenna, indoors, as the signal pick-up, in lieu of the more orthodox systems, such as a wire strung around the room, or an aerial atop the roof. We will return to this phase of the design a little further on. At the moment, we are interested in ways and means of obtaining an R.F. amplifier of high-gain type and without moving parts.

Shielding and Bypassing Details

Shielding and bypassing are so important in a circuit of this nature that too much stress cannot be placed on these particular points. Circuit stability and the degree of

amplification depend upon the efficiency with which these factors are handled. To simplify the mounting and wiring of the components, with due regard for the necessity of adequate shielding, the amplitenna was designed to mount every part on the aluminum sheet which forms the base of the shield-can. (Fig. 4 is a drilling layout.)

Thus the shield cases shown dotted in Fig. 1, of L1 and L2 are grounded. While this is true also of the shield around R.F.C.1, it is not true for the metal hemi-

sphere within which is contained the coil comprising the "antenna" type Akaformer; this case is inverted, mounted in this position and insulated from the chassis, and connected to one side of the mica-insulated coupling condenser, C5, which

Here is a high-gain R.F. amplifier which has no moving parts, requires no circuit aligning, has no controls to operate except an off-on switch, costs very little to build, is self-powered, and which is designed for easy assembly. Connect this instrument wherever you want to have high amplification of broadcast frequencies of 550 to 1,500 kc.

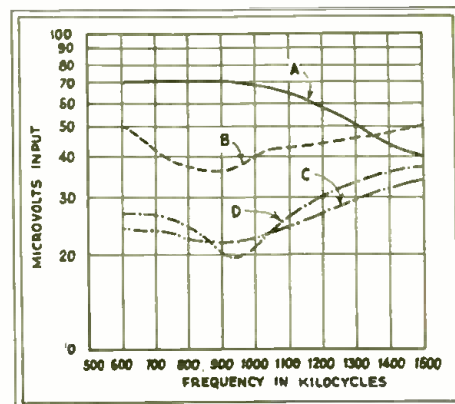
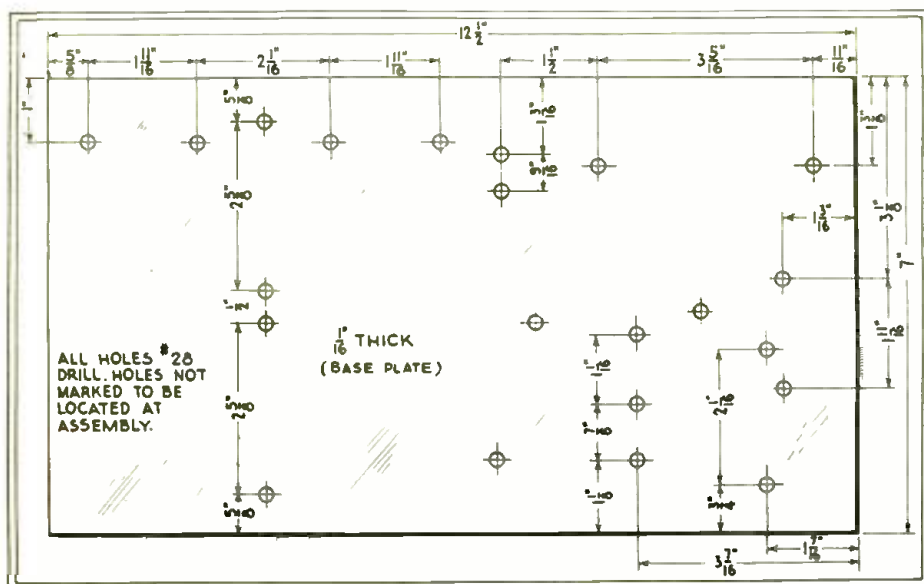

Fig. 4, left
Arrangement of the mounting holes to accommodate the apparatus of the "amplitenna."

Fig. 5, above
Frequency characteristics of an R.F. transmission line. At A, a set with low-impedance input; B, same set with matching transformer; C, a set with high-impedance input; D, same with transformer.

ouples the output of the entire amplifier to this "matching transformer."

Long leads are anathema in a circuit of this type, while adequate bypassing is not merely an idea to enrich the condenser manufacturer, but actually an absolute necessity. Note particularly that non-inductive condensers are specified in certain positions.

The cap leads to the 58's must be shielded, and the shields grounded; inductances L1, L2, have leads of this type. Be careful that one or two strands of this shielding are not permitted to wander about, as they may reach to the rubber-covered conductor within and cause a short-circuit, thus rendering the entire assembly inoperative.

Adequate screening calls for shield-cans around all the tubes. These shields appear in the interior view of the amplitenna, Fig. B, and their design is an important factor influencing the effective grid-plate capacity of the type 58 tube. When the shield-can is provided with a collar which closely fits the tubular part of the dome, the combined effect of the can construction and the internal shield will give low effective grid-plate capacity. If shielding is used, as specified, sufficient ventilation should be provided to avoid overheating the tube, since the surface temperature of the bulb, at the hottest part, should not exceed 150 deg. F.

Reducing Cross-Modulation

The long "cut-off" or variable- μ feature of the type 58 tube effectively reduces cross-modulation which otherwise would result with strong local stations in operation. That is, the variable- μ characteristic of the tube permits its control-grid potential to swing over a considerably greater range than when other types of tubes are used, before the tube curvature can become sufficiently distorted to cause detection; (even then, it is impossible to obtain linear detection with this tube). While it is true that greater sensitivity could be obtained if tubes of the same general construction, but lacking the variable- μ feature, were employed, this point bears no weight in the present instance as the amplification obtained with the present design is sufficient, in most instances, to make an ordinary slight background noise sound like Niagara!

In order to afford some means of compensating for slight discrepancies in design and construction, and to allow for differences in the input system of receivers with

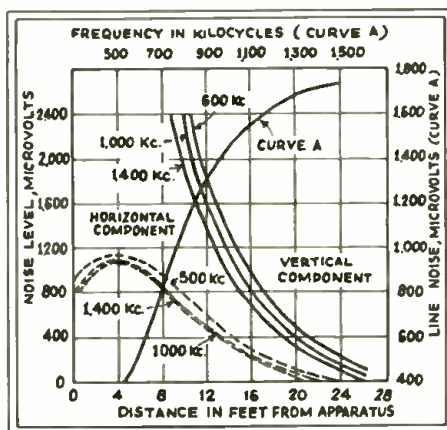

Fig. 6
Curves of noise radiation via air and, A, wire.

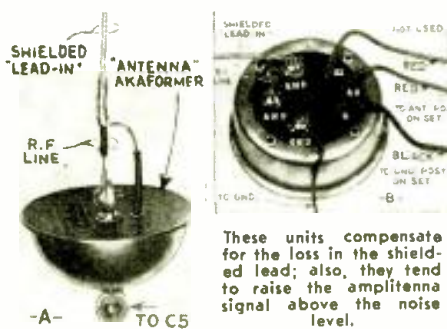

Fig. C
Akaformer units: A, "antenna"; B, "set".

which the power antenna may be associated, a volume control is provided, R1, which may be adjusted through a small hole in the side of the overall shield-can, as shown in Fig. A, (and the illustration on the cover). Once adjusted for a given set-up, it need not be manipulated again.

Characteristics of the 82

It should be noted that with condenser input to the filter, the peak plate current of the tube is considerably higher than the load current. With a large condenser in the filter circuit next to the rectifier tube, the peak current is often as much as four times the load current!

(Under operating conditions, the 82 has a bluish-white glow filling the space within the plates and extending to some degree into the surrounding space outside the plates. This glow, caused by the mercury vapor, is an inherent operating characteristic of the 82. Service Men find this effect a very convenient means of checking the performance of the associated equipment as a whole,—fluctuations and variations in current demand being reflected in the 82 as a variation in the appearance of the blue glow.)

It is characteristic of mercury vapor rectifiers that no appreciable plate current will flow until the plate voltage reaches a certain critical positive value. At this point the plate current rises steeply to a high value in a small fraction of a second. This surge of current recurs each time either plate becomes positive, and produces highly damped R.F. oscillations which may excite circuits in the immediate vicinity of the tube and thus result in noisy operation. (Therefore, condenser C8 should be of minimum capacity.) In consequence it is necessary to completely enclose the 82 in a metal shield-can, which is then grounded. (The shield-can, shown in Fig. B alongside the rectifier, V4, is not so "hot," as it gets too hot (!)—it should have greater ventilation. Notice the considerable increase in background noise when this shield-can is permitted to float ungrounded.) It is also necessary to place a small R.F. choke of low distributed capacity, R.F.C.2, R.F.C.3, in each plate lead so that the R.F. surge to the filter is reduced sufficiently to eliminate impact excitation.

(Continued on page 503)

AN EXPERIMENTER'S LONG-WAVE TUNER CHASSIS

SAMUEL WHISK

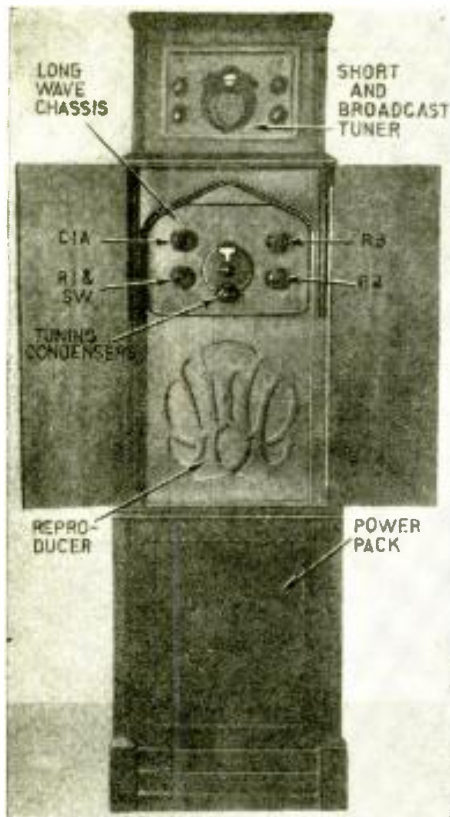

Fig. A

External view of the 550 to 2,000 meter receiver designed and constructed by the author. This receiver is also equipped with a standard short-wave and broadcast receiver, as shown above. Note the symmetrical arrangement of the tuning controls.

One of the first descriptions of a custom-built 550 to 2,000 meter receiver, for the reception of foreign stations.

A SHORT time ago the writer completed a *real* all-wave receiver. At least, it included not only a short- and broadcast-wave tuner, but, it also comprised a so-called long-wave section to cover the 550 to 2,000 meter band. The performance of this long-wave, tuned-radio-frequency chassis so interested the editors of **RADIO-CRAFT** that the writer was prevailed upon to "write it up" as a unit apart from the rest of the machinery.

As will be seen by reference to the front view of the entire set, Fig. A., a

very symmetrical arrangement of the controls has been secured. As the set is in the nature of an experimental job, it is a bit more complicated than it otherwise might be, in that there have been provided not only the usual off-on switch and volume controls, but also regeneration—oscillation, and sensitivity controls.

If the constructor wishes to follow the original parts placement, he may refer to Fig. B; however, the writer does not feel that there is anything critical in this phase of the work, provided the long-wave coils are shielded and due care is given to the wiring.

Schematically, the circuit is that of a T.R.F. receiver, as may be seen by reference to Fig. 1. Since A.C. power packs are no longer a problem to most set builders, and as many experimenters may prefer to use an available power supply, no attempt has been made to show the power pack, either in picture or diagram form; besides, the pack used in this arrangement was designed to power the whole assembly.

General Problems

Designing this long-wave chassis was not all "peaches and cream." Far from it. It was one thing to establish the premise that the set must be capable of picking up overseas programs direct

(Continued on page 489)

STATIONS HEARD

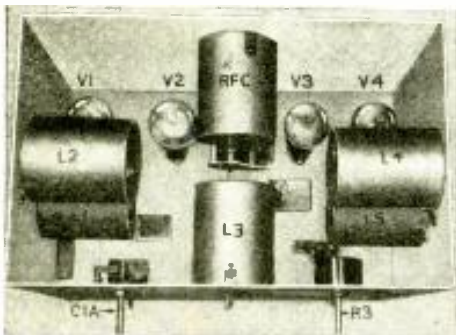

Fig. B

An internal view of the receiver showing the location of the parts before wiring.

● THE AUTHOR furnishes the following list of long-wave stations heard with this receiver early one morning, just after the set had been completed for test:

KDKA, about 1,000 meters, special high-power testing (nearly wrecked the reproducer!);

Warsaw, Poland, 1,400 meters;

Vancouver, British Columbia (unidentified);

Radio-Paris, France, 1,725 meters;

Also, the following long-wave navy aircraft beacon phone stations:

WWZ, Seattle, Wash.; WWU, New Brunswick, N. J.; WWX, Washington, D. C.; KMQ, Manila, Philippine Islands.

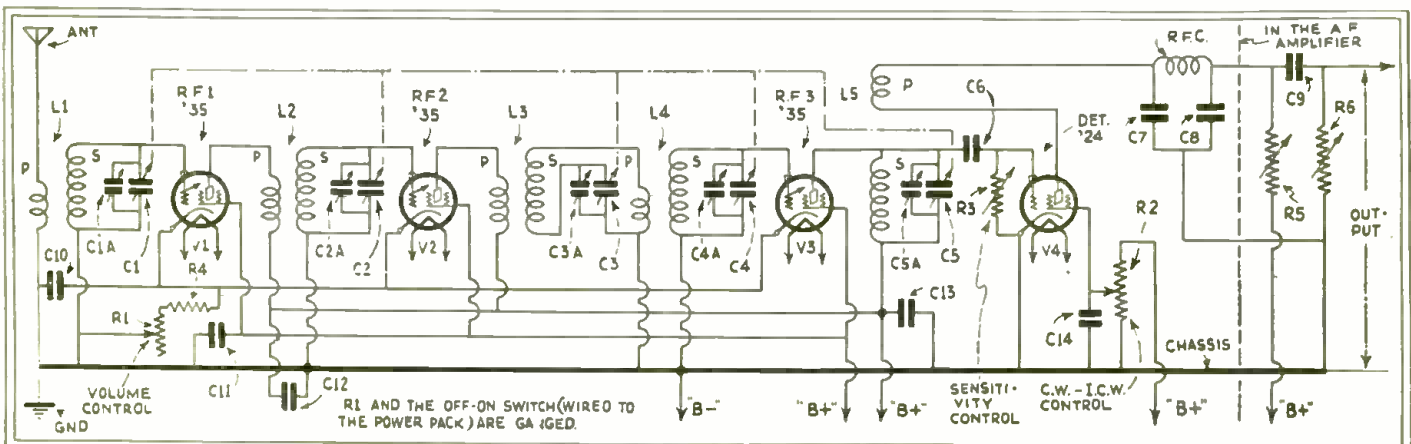

Fig. 1

Complete schematic circuit of the receiver. Any standard power unit may be used, as may any audio system. Standard voltages are applied to the tubes.

THE LATEST RADIO EQUIPMENT



Photograph of the new Hickok Statiktester.

NEW STATIKTESTER BY HICKOK

THE illustration to the left shows the new Hickok Statiktester which is, in reality, a portable testing laboratory. The following measurements may be conveniently made with this device: D.C. voltages up to 1,000 volts; A.C. voltages up to 800 volts; D.C. current to 200 ma.; A.C. current to 200 ma.; resistance (ohmmeter readings) from .25-ohm to 20 megohms; capacity ranges from .05- to 15 mf.; electrolytic condenser leakage and capacity; all values of inductance from .5- to 50 henries; tube-testing facilities for all the new tubes.

As may be seen by reference to the photograph, all the controls necessary for manipulation of the device are on the panel, and all necessary adapters are housed in the cover.

UNIVERSAL "MIKE" STAND

THE Universal Microphone Co. has just released for sale a new microphone stand which is illustrated below. A feature of this stand is that it may be adjusted to almost any height desired because of its concentric tube construction. The holder for the mike is designed for a spring support.

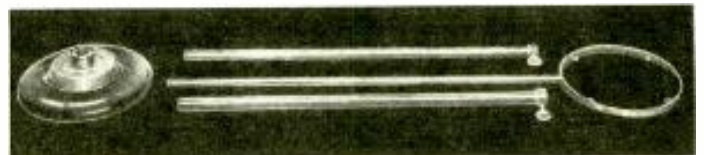

New Universal microphone stand. Note the sections.



The mike-amplifier.

NEW "MIKE"

THE Sound Engineering Corporation announces a new microphone and amplifier shown to the left. The output of this condenser-amplifier is equivalent to that of a condenser mike and may be adapted for either a 200- or 500-ohm line. There are no high-frequency peaks to mar response, as in other mikes.

HEADPHONE-CRYSTAL SET

THE unique device illustrated below is a complete radio set in a pair of telephone receivers. You connect the antenna and ground to the phone tips, and tune. It is distributed by H. H. Burt in America.



New German telephone-receiver.

NEW SPARTON RECEIVER

THE new Sparton receiver illustrated below is one of a group designed to incorporate the latest ideas in radio. It is a thirteen tube receiver and is equipped with three dynamic speakers. The details of this set were published in the December, 1932, issue of this magazine.

The Lafoy system of automatic volume control is used; this system also having been described in the July, 1932, issue, page 37, Data Sheet No. 70. The set has a sensitivity of 4 microvolts, absolute, and an undistorted output of 20 watts.



Photograph of the triple-speaker "Triolian" receiver.

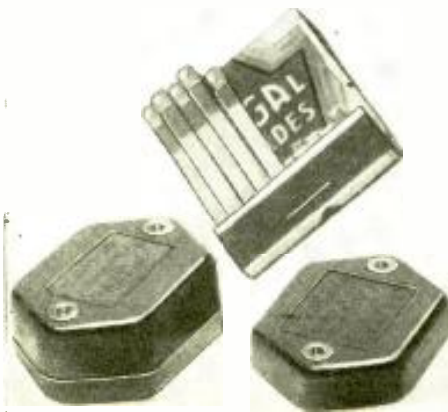

Two type 9 Dubilier mica condensers.

DUBILIER PRODUCTS

THE Dubilier Condenser Corp. announces a new type of molded mica condenser, known as the type 9, for transmitter, high-grade receiver, and power amplifier work. A new type of low loss molding compound is used, which is claimed to be more efficient than the usual run of bakelite types formerly employed. They are made with an accuracy of 10%, and are furnished with either 6/32 in. tapped holes or with clearance holes for No. 6 screws. They are made in sizes from .00005- to .05-mf., and have a breakdown voltage of 1,000 and more. They are approximately 1 1/8 x 1 1/4 inches.

NEW YAXLEY PARTS

YAXLEY announces a new combination switch and variable resistor shown in the upper part of the sketch below. By means of the set screw, the switch may be entirely disconnected, *not even snapping*. The lower photo-

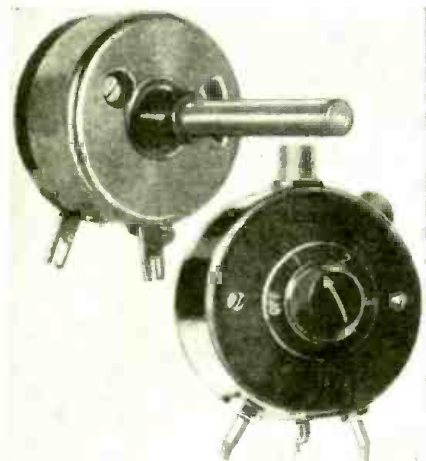

Two new Yaxley parts ready for distribution.

graph is a new portable station selector volume control, designed to control volume to headphones or speaker.

THE NATIONAL "JIGGER"

A REAL novelty. When placed in front of your loudspeaker, the

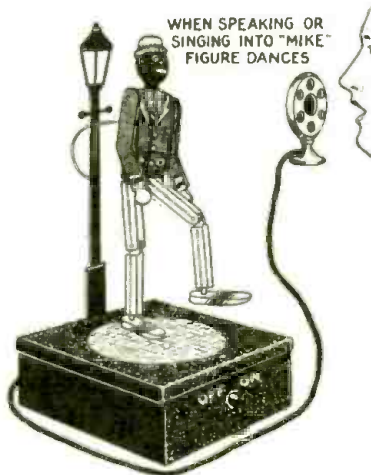

The New National "Jigger."

small mike causes several relays to operate, which, in turn, makes the jigger jig to the tune of the program. Made by the National Co. One of the "gadgets" referred to in our Editorial.

AUTO SUPPRESSOR KIT

"PROTECT-O-PACKED," this new resistor kit by Continental Carbon contains a variety of ignition suppressor parts suitable for 4's, 6's and 8's.



The Continental suppressor kit.

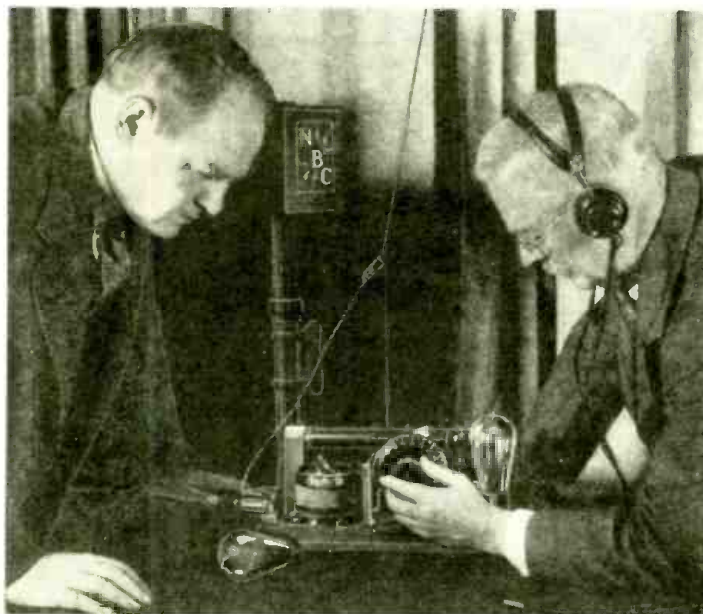

Left, Mr. O. H. Caldwell; and right, Dr. Sharp tuning the simple receiver with the 50-year old Edison tube.

50 YEAR OLD EDISON LAMP USED IN RECEIVER

HAS radio really advanced? Is present-day equipment really more sensitive, and does it really give better quality than the older radio equipment? These questions are most conveniently answered by referring to the two photographs shown at the left.

It seems that about 50 years ago, Thomas Alva Edison discovered that if a cold metallic plate of some sort be placed around the filament of his incandescent lamp, there would be a flow of current from the filament to the plate. This effect, as will be readily recognized, is the fundamental principle of our modern vacuum tube. In order to obtain qualitative as well as quantitative data, Edison built several such "radio tubes," and one of them is shown in the photographs to the left.

The original model of Edison's lamp was recently connected in a double-circuit tuner by the National Broadcasting Co. They picked up a signal from WJZ on the little receiver and fed the output to the input of WEAF for rebroadcasting purposes. Listeners all over the country state that the reproduction was as good as the ordinary programs. Dr. Clayton H. Sharp, well-known scientist, is shown tuning the set (which has a range of about one-half mile) while O. H. Caldwell, President of the New York Electrical Society, looks on.

The lamp has a carbonized bamboo filament surrounded by two upright thin wires which Mr. Edison used as the plate. The schematic circuit of the set is shown: it is simple, and was run directly off the 110-volt D. C.

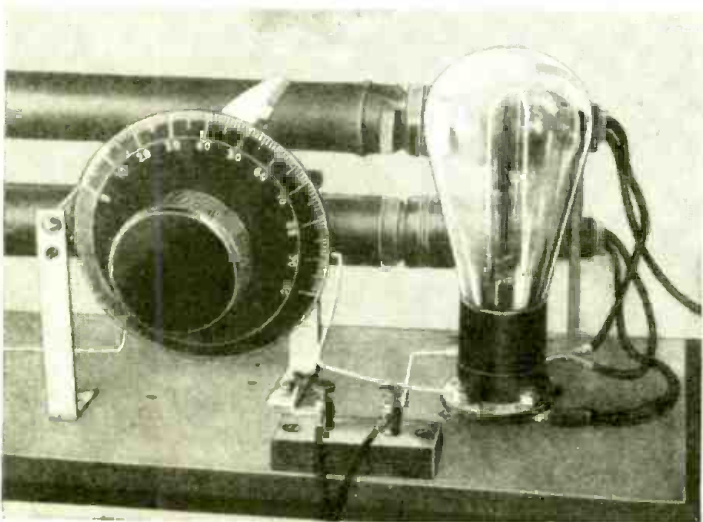

Close-up of the Edison receiver; the two wires serving as the plate are clearly shown.

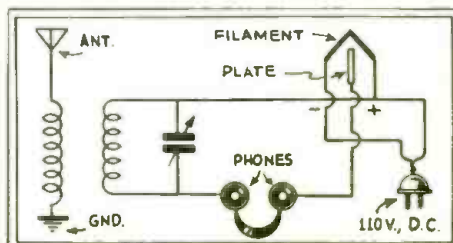

Schematic circuit of the double circuit receiver.

line. The large resistors shown were used to gradually bring the filament voltage up to 110-volts.

Now, radio men, do you think radio has advanced in the past fifty years?

THE INTERNATIONAL "KADETTE"

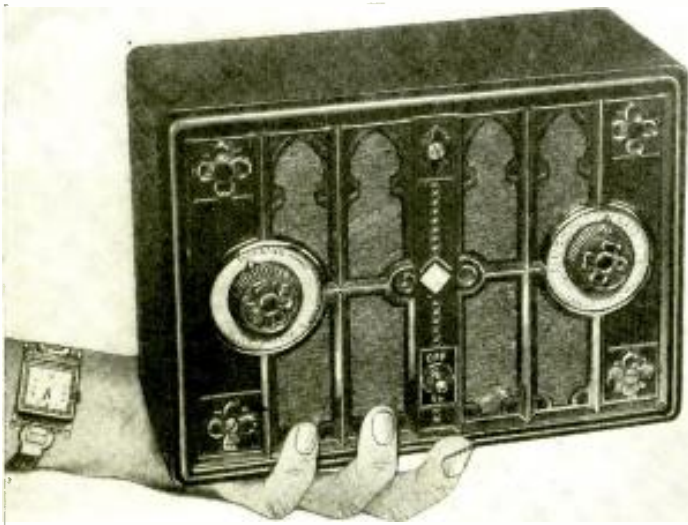

Here's the famous International "in the flesh." Schematic circuit and detail photographs appear elsewhere on these pages.

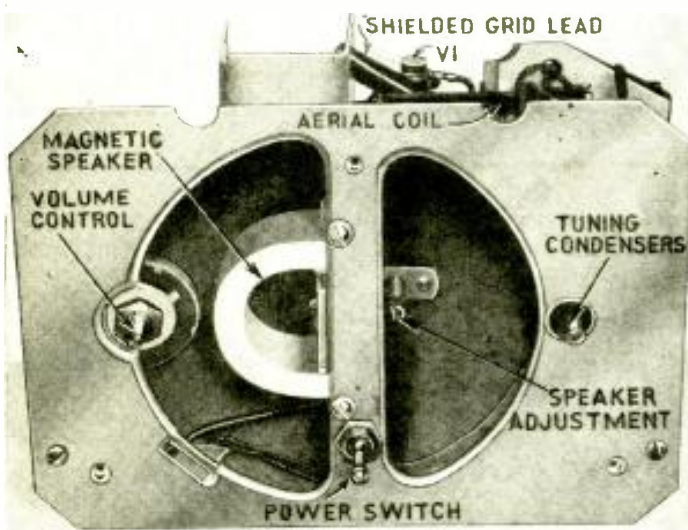

Another view showing the front of the set with the cabinet removed. The adjustment for the speaker is clearly illustrated.

A NEW radio receiver, ideal for use in traveling, has recently been introduced. These sets are made to be used on all common power lines, including 110 volts A.C., either 60 or 25 cycles; 110 volts D.C.; 6 volts D.C. with an automotive "B" power unit; or 220 volts A.C. or D.C. with an adapter.

It is readily seen that these sets are truly "universal." The complete receiver, including the aerial and power plug, is housed in a bakelite cabinet $8\frac{1}{2} \times 6\frac{1}{2} \times 4$ inches—little more than a good sized hand full. And it weighs only 6 pounds!

The bakelite cabinets are also an innovation. The manufacturer chose bakelite for its neat appearance, light weight, and also because bakelite is not easily scratched or marred in use. The cabinets are furnished in a number of attractive colors to match "milady's boudoir."

The Circuit

So much for the appearance of the set. The circuit is a conventional T.R.F. arrangement with several novel features that distinguish it from the ordinary. In the first place, the filaments of the four tubes in the set are all connected in series. This includes the type '39 R.F. tube, the type '36 detector, the type '38 audio amplifier and the

type KR-1 rectifier. These tubes are of the type designed for automobile use, with 6 volt filaments, drawing 0.3-ampere. The type '36, '38, and '39 tubes are pentodes, designed for the purposes used, while the KR-1 is a mercury-vapor rectifier made for the "B" power units of automotive sets.

Reference to the circuit in Fig. 1 shows the positions of the four tubes and the circuit for the series filaments. The resistor R7 is a long wire wound unit, running the entire length of the receiver, and reduces the voltage of the 110-volt supply to 24 volts for the filaments. The KR-1 tube is a heater type, so that its filament is not in the plate supply circuit, but simply heats the cathode. The latter circuit is connected through a filter choke to the plates of the three tubes. It is interesting to note that the screen grid of V2 is connected to the cathode of V3. In this way the screen grid is supplied with the low positive potential required for detection, by the voltage drop in R6. This method of connection eliminates the need for a separate resistor for the screen-grid bias and, at the same time, it saves a bypass condenser. Condenser C8 serves as a bypass for both the screen grid of tube V2 and the cathode resistor of V3.

The method of coupling the various stages together is also slightly out of the ordinary. The aerial coupling coil is quite large and is lattice wound, on the same form with the secondary. In addition, a small coil of three turns is wound directly over the secondary and connected to the aerial condenser. This coil supplies a small amount of capacitive coupling between the aerial and the secondary coil for the purpose of equalizing the coupling over the complete band. An aerial condenser of .0001-mf., C1, helps to sharpen the tuning and isolates the aerial from the set in case the latter touches the power line, etc.

The plate of V1 is coupled to the grid of V2 by a small capacity. This capacity, shown in the diagram, consists of an insulated wire about four inches long wired to the grid of L2. A smaller wire wound around this insulated wire over the full 4 inches and connected to the plate of V1, supplies the coupling capacity. The lead from the tuning condenser of V2 is shielded carefully by a twisted wire wound around it and grounded to the chassis of the set. The chassis of the receiver is insulated from ground. An 0.1 mf. condenser, C12, is used to connect it electrically to the ground.

A small piece of wire (X) at one end of the grid circuit of V2 is placed in the field of the aerial coil L1, evidently to introduce a small amount of regeneration to increase the sensitivity of the receiver.

The detector tube is coupled to the audio tube by the ordinary resistance coupling method. This consists of condenser C6 of .002-mf. and the two resistors, R4 and R5. The screen grid of the audio tube V3 is connected to the plate supply circuit and is effectively at the same potential as the plate of this tube. The magnetic speaker is connected directly in the plate circuit of V3 and is evidently matched to the plate impedance of this tube.

The volume control, R2, consists of a variable resistor

THE GREATEST SET OF THE YEAR!

Undoubtedly, the International "Kadette" described here is now enjoying a greater sale than any other radio set on the market. It has been imitated, but, so far, never duplicated. RADIO-CRAFT presents, with pride, the first technical discussion of the "original."

THE MANUFACTURER of the International "Kadette" taught the radio industry a lesson which will not be forgotten so soon. Quietly and without fuss, during the last year, this company, a newcomer in the radio field, tackled the problem of radio merchandising in a brand new way. They sold radio sets where they had never been sold before. Instead of going to radio outlets, they went to dry goods stores, sporting goods houses, jewelry shops, and even clothing shops. Indeed, they left all radio outlets severely alone.

They placed a good price on their product, and turned out not only an original, but a remarkably new type of radio set that took like wildfire, and threatens, indeed, to become the largest radio seller in America now.

The manufacturers also took cognizance of the depression and sold a first-class radio set at a price to fit the country's pocketbook today.

Radio still is a good business, if you know how to go about it and get out of the beaten path.

with a maximum value of 200,000 ohms, in series with a 150-ohm wire-wound fixed resistor, R1. The latter resistance prevents the bias from being dropped too low. The volume control circuit is connected in the cathode and suppressor circuit of the radio-frequency tube, V1. It is bypassed by a .01-mf. cartridge type condenser, C4.

Another peculiarity of the circuit is the use of a large lattice wound coil, L4, in the plate circuit of V1, placed quite close to L2 that evidently serves the double purpose of supplying some coupling to the grid coil of V2, and in addition, acts as a radio-frequency choke coil. This coil is mounted at the end of L2, and at right angles to the direction of the windings in the latter coil.

The Operation

In operation, the set acts differently on each type of current supply. On a 110 volt A.C. supply, either 25 or 60 cycles, the current is supplied directly to the filaments of the tubes, which are all of the heater type. The A.C. supply is also applied to the plate of the half-wave rectifier, V4, through resistor R8 which has a value of 75 ohms, and is bypassed by condenser C11. The rectified plate current from the mercury-vapor tube is filtered by a choke coil L3 and two electrolytic condensers C9 and C10. This filtered direct current is then applied to the plates, grids, and screen-grid circuits directly or through resistors, depending on the voltage required.

In operation on the 110 volt D.C. line, the power plug is inserted into the socket the same as for A.C. operation, without any switching, or other changes. The current is applied to the series filaments, and the current for the plates and grid circuits is passed through the rectifier V4 and the filter circuit in exactly the same manner as for A.C. If the plug is inserted correctly in the socket, the positive pole is connected to the plate circuit of the rectifier and the current is passed through, without any change except for some filtering in the choke coil and condenser circuit. If, however, the plug is inserted incorrectly in the socket, the negative pole is connected to the rectifier plate and no current flows. Thus, it can be seen that no harm is done if the plug is reversed, but the set will not operate until its connection is correct.

When using the set in an automobile, the special adapter plug is employed. This adapter connects all the tube filaments in parallel for operation from the 6-volt battery. The plate supply is furnished either by "B" batteries, or from an automotive "B" supply. In this case, the plate current is applied to V1, V2, and V3 without passing through V4, or the filter. V4 is not used for automotive operation.

The only remaining type of operation is from 220 volts, either A.C. or D.C. There are very few places in the United

(Continued on page 502)

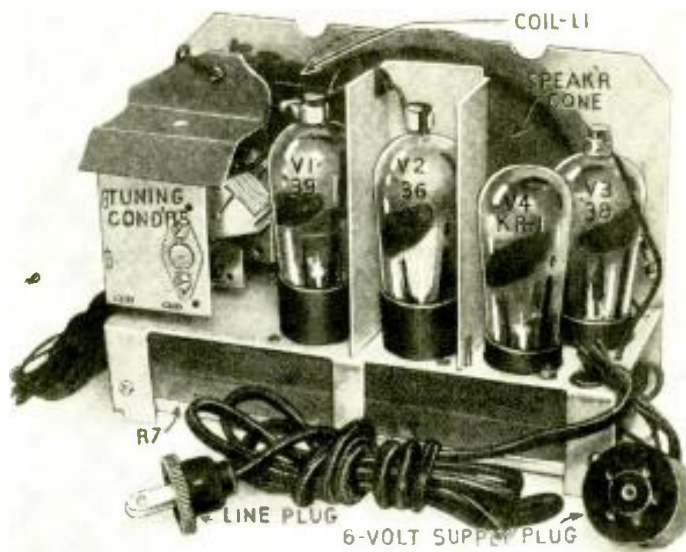

Rear view of the famous receiver. Note how every bit of space is utilized to good advantage.

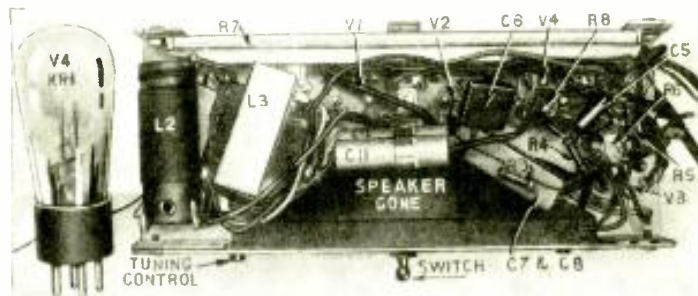

An under-view of the set. Socket connections and parts are in a huddle, here. The depth of the set may be estimated by comparison with the tube at the left.

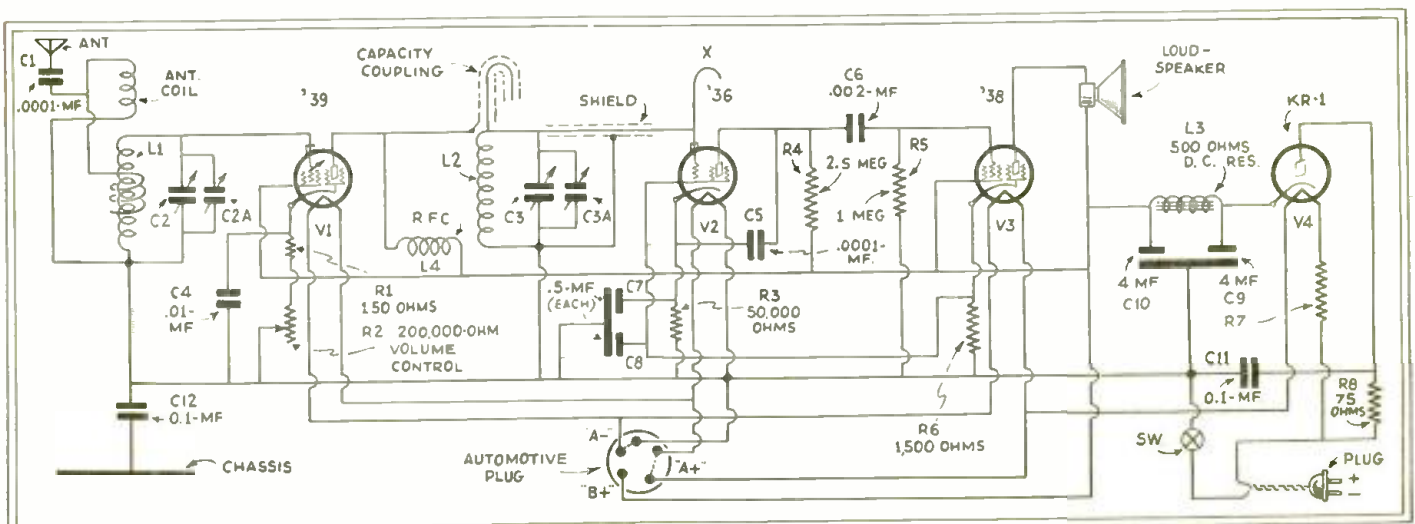

Fig. 1

Schematic circuit of the International "Kadette." This circuit is reproduced for the first time in any radio publication.

SOME INTERESTING LOUDSPEAKER FACTS

The third of a series of articles which deal with multiple speakers. This vitally important subject is fully discussed in this, the final installment.

ELI M. LURIE

PART III



Fig. B

The low and high-frequency speaker combination used so effectively by the Bell Laboratories. (Photograph courtesy Bell Telephone Laboratories.)



Fig. A

The high-frequency speaker developed by the Bell Laboratories to respond up to 12,000 cycles. (Photograph courtesy Bell Telephone Laboratories.)

THIS is the age of specialists. No matter where we turn we see evidences of this fact. In radio we find no exception. In the hour of need, when new developments are not forthcoming, these same specialists are forced to review all past performances and, somehow, twist something from the past into a new creation and bring it forth as a beautiful thing . . . to be adored . . . praised . . . to put on a pedestal . . . like a false god. And, so, we have new developments . . . oftentimes taken from the past.

This does not mean that we do not occasionally produce an excellent device, materially improved, by the addition of other new developments; for some of our best equipment is made in this wise. Sometimes, however, instead of an improvement there is a decided cheapening of the product until it is much inferior to the article from which it was originally created.

In brief, this is the story of the Dual Loudspeaker . . . taken from the past.

Through certain sources of information, it has been found that the whole movement toward dual loudspeakers is the result, primarily, of propaganda initiated by loudspeaker manufacturers. It is the aftermath of a past experiment that was presented by the Bell Telephone Laboratories in an effort to produce a practical system of reproduction that would cover the audio spectrum up to about 12,000 cycles. The Bell Laboratories required such a system in order to reproduce phonographic recordings upon which, by a new process, they were enabled to record as high as 12,000 cycles.

Since they had no speaker available for such high-frequency reproduction, and since it was agreed that even if one were available it would still be of no practical value for use on the low-frequencies, an entirely new type of speaker was conceived. This instrument was designed to operate from 3,000 cycles up to and including 12,000 cycles. For the lower frequencies, another speaker, especially suited for such work, was used. The high-frequency speaker is shown in Fig. A and a section view in Fig. 1. In Fig. B is shown the arrangement consisting of both high- and low-frequency loudspeakers. In conjunction with each speaker, a simple network or filter is used to allow only those frequencies which are in the efficient range of the speaker to be reproduced by that speaker. Such a system is undoubtedly the best yet devised, and response tests have indicated that it is possible to greatly improve the response characteristic through its use.

There are two methods of utilizing the experiment of the Bell Labs.: First, by doing the same thing, viz. using two or possibly three speakers and having each speaker designed to cover only a portion of the spectrum with its highest efficiency in that portion. Such combinations are shown in Figs 2A and 2B. Each speaker should include a hand-pass filter that should conform to the operating frequencies by allowing all of the frequencies to

be handled by a given speaker to pass by, cutting off sharply on each side so that all other frequencies are eliminated. Thus, what one speaker would reproduce, would not be reproduced by either of the others. The second method (Fig. 3) is to use the same two, or possibly three, speakers, but instead of connecting the band-pass filters to each speaker, separate output amplifiers are used for each individual speaker. Now each of these amplifiers is also designed to cover only the operating portion of the speaker which it is to feed. This is accomplished through the use of tuned input and output transformers, or by similar tuned cascade arrangements of either impedance or resistance coupling. At the input of each tuned amplifier is a band-pass filter also tuned to the same band. Though the latter is not entirely necessary, it is effective in that it limits excessive voltages of wrong frequencies from being applied to the input circuits.

In the June 1929 issue of the *PHYSICAL REVIEW*, in an article by Wolff, it is claimed that when two speakers are placed in an infinite baffle (buried in the earth, *Editor*) with their edges touching, there is a reinforcement of the low frequencies. The theory behind this effect is perfectly sound, and has been confirmed in perhaps the finest equipped laboratory for sound measurements in the world.

The practical magnitude of the effect, however, is not as large as a layman would expect when he is told that the power at the low frequencies is doubled under these conditions. The *maximum gain* is only 3 DB, and to the ordinary listener, constitutes just a perceptible difference. From Dr. Wolff's data, it may be deduced that the gain is 2.3 DB at 500 cycles, less than 1 DB at 700 cycles, and zero at 850 cycles, and this *when their edges are in contact and the speakers are mounted in an infinite baffle*. Also, it only applies to speakers using 8-inch cones.

When the speakers have cones that are not of the same size, then each cone will have a different fundamental

period. This means that even though they are traveling in phase, when one diaphragm is vibrating at resonance and the other is not, their motions will be somewhat out of phase, with a resulting loss in efficiency which would not happen under conditions of perfect phasing. Many receivers on the market use two speakers with different size diaphragms which, it is seen, are contrary to Dr. Wolff's results.

In the face of a certain amount of theory supporting the dual-speaker arrangement which has already been explained, the cause of the poor results usually obtained is not at once evident. One reason, aside from the generally poor quality and cheapness of some of the speakers employed, is the effect of the sharp resonances which occur in the high-frequency range. These resonances not only occur in cheap speakers, but even in fairly good ones. (This was discussed by the author in the October issue of *RADIO-CRAFT*.)

Now these sharp resonances that occur in the high-frequency range produce both frequency distortion and transient distortion. When dual speakers are used, and these speakers are peaked at different frequencies in the lower end of the spectrum, a partial compensation results, and there is a slight flattening out of the frequency characteristic over these lower frequencies, giving better quality. But the fact that the speakers contain low-frequency resonant peaks, high and sharp enough to modify the response, is a confession that the speakers themselves are of exceedingly poor quality.

The cause of such a peak is primarily due to low damping in the system. This may be due to a number of causes, the chief of which is a low value of electro-mechanical damping because of the use of weak fields and small driving coils; other causes are stiff spiders and the use of paper edge suspensions.

In contrast with this effect, it has been found that in the case of a well-designed speaker in which quality is paramount, the low-frequency resonant point cannot be detected in the response curve, even when the latter is made out-of-doors so as to eliminate any room effects. The reason for this good performance is that provision has

been made for a strong magnetic field across the air gap and the use of sufficient wire on the driving coil. Also, the electro-mechanical damping is affected by the electrical impedance (tube impedance) which the loudspeaker faces, it being less for the higher impedances which are generally associated with pentodes and class B operation.

Thus, the ultimate result is that the frequency distortion in the higher frequency range increases with the addition of each speaker; for whereas we only had the distortion of this type from one speaker, the addition of the second speaker produces its own distortion which is added to the other.

Now in regard to the second type of distortion, which is transient distortion, this is also multiplied with the addition of each speaker; for if only one speaker were used, there would only be one low frequency at which transient distortion could take place instead of the two low frequencies, which would result by the addition of the second speaker operating at a different pitch from that of the first speaker.

One manufacturer suggests that the gain in efficiency through this system would warrant the use of lighter cones with the corresponding increase in efficiency (through their use); but the fact that the lighter cones would tend to "break-up" on strong signals, of course, eliminates such a procedure.

Since it is evident that a gain in low-frequency response can be obtained, and also since it is possible to materially improve the entire frequency range so far as the response characteristic is concerned, several arrangements will be described which follow the logic already explained.

First, it is well to remember that since the efficiency decreases with a change in the size of the diaphragms, the actual size of both diaphragms (if two speakers are used) should be the same. Both speakers should also be well designed with adequate field strength, and the speakers should have little, if any, noticeable sharp resonant peaks in the lower frequencies.

In eliminating these sharp, low-frequency resonant peaks we also eliminate the transient distortion which is

(Continued on page 490)

YOU SHOULD READ THIS ARTICLE BECAUSE

Almost every receiver now being manufactured is using two or more speakers;

Most manufacturers do not know how to use multiple speakers properly;

The author tells you what has been done and what CAN be done with two or three speakers, properly used.

IT CONTAINS VITAL INFORMATION FOR YOU

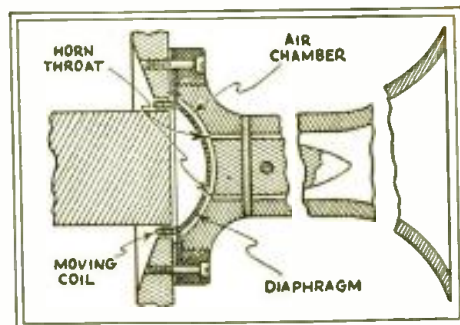

Fig. 1
Cross section of the high-frequency speaker photographically illustrated in Fig. A

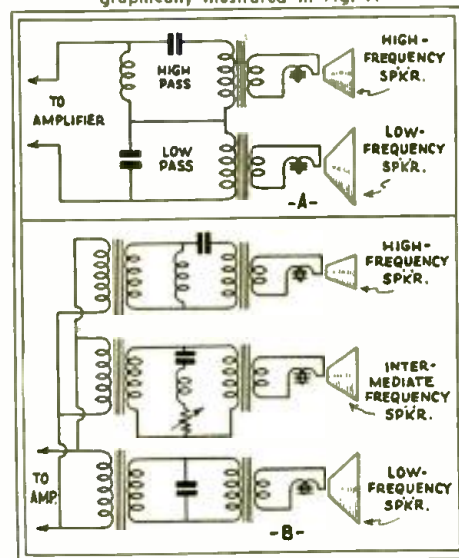

Fig. 2
The circuit of A shows the use of filters arranged for dual-speaker operation; at B, the arrangement for triple-speaker operation. Note the connection of the filters.

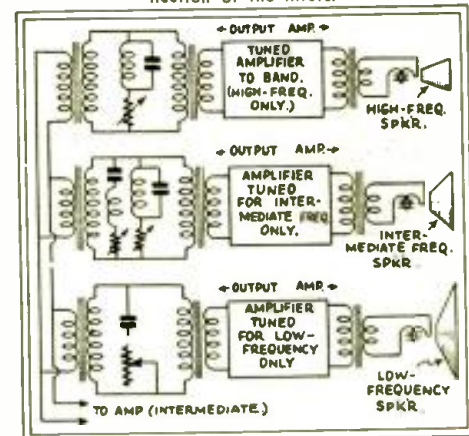

Fig. 3
Triple-speaker operation with the filters in the amplifier.

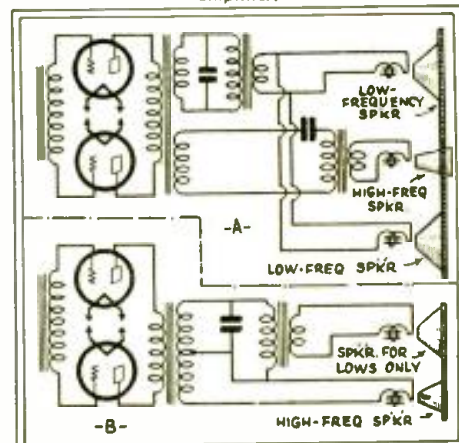

Fig. 4
Speaker arrangements for three, at A; for only two, at B.

SLEUTHING FOR STATIC

GLENN H. BROWNING

Here is an unusual article by a radio authority, designer of the famous Browning-Drake receivers, on locating interference, which is bound to knock some of your older theories into a cocked hat. Mr. Browning describes an instrument for locating sources of interference which uses a non-directive antenna, and actually measures the amount of noise coming in through your power line or via the aerial.

THAT most radio interference "static" is not due to uncontrollable natural causes such as thunderstorms, northern lights, heat lightning, etc., but is created by electrical equipment, the installation and operation of which is readily subject to legislation, is at last receiving the cognizance of the public at large.

In fact, the subject of radio interference has received international attention. At the meeting of the International Technical Consulting Committee on Radio Communication, held at Copenhagen last June, the question of radio interference from electrical apparatus was discussed at some length. Here in the United States a committee known as the "Joint Co-ordination Committee on Radio Reception" of the National Electric Light Association, National Electrical Manufacturers Association and Radio Manufacturers Association has been appointed to investigate the interference problem and take the necessary steps toward reducing man-made static. Many communities have passed ordinances prohibiting the operation of interference-producing equipment.

Methods of solving controllable static problems are of importance not only to the broadcast listener, who finds that the pleasure of program reception

has been spoiled, but also to other interests. Power companies have learned that sparking power equipment is a costly proposition; program sponsors have found that it pays to assist listeners, who report poor reception, to better their local conditions. Insurance companies welcome knowledge of interference due to defective electrical equipment, since such devices represent fire hazards. Storekeepers, and even householders, are amenable to a reasonable argument by the Service Man, pointing out the saving which may be affected by locating and eliminating power leaks in signs, domestic appliances, etc.

However, locating the source of the disturbance in a reasonable time is almost an occupation in itself, quite apart from that of applying the usual corrective measures—requiring units of inductance, capacity and resistance in combinations suited to individual needs. (The corrective phase of static elimination has been discussed in the three-part article, "Causes and Cure of Interference," by F. R. Bristow, in the January, February and March, 1930 issues of RADIO-CRAFT.—*Technical Editor.*) The work of the interference trouble-shooter is divisible into three classifications, as follows: (1) location of the interference; (2) measure-

ment of the field strength of the interference; and, (3) measurement of the field intensity of broadcast signals which may be affected by the interference. A commercial test instrument designed to meet these conditions is the Tobe model 232 Interference Locator illustrated in Fig. A; its control-panel markings are clearly shown in Fig. B.

The Interference Locator

It has been common practice for the "interference hunter" to employ some type of portable radio receiver having a loop antenna (The now obsolete Radiola 26 superheterodyne was an old favorite for this type of work.—*Technical Editor.*), and to make a survey of the disturbed territory. However, in the field, the loop antenna proved to be in error with regard to the direction of the interference in a large percentage of cases, due to the fact that metallic wires conducted the signal along them, and also due to radiations from metal buildings, etc. Consequently, it was found that a non-directional type of pickup was preferable, for then the interference could be tracked down by going towards the point of maximum signal. The signal strength was for some time determined by ear alone, which was unsatisfactory because of the ear's characteristic of

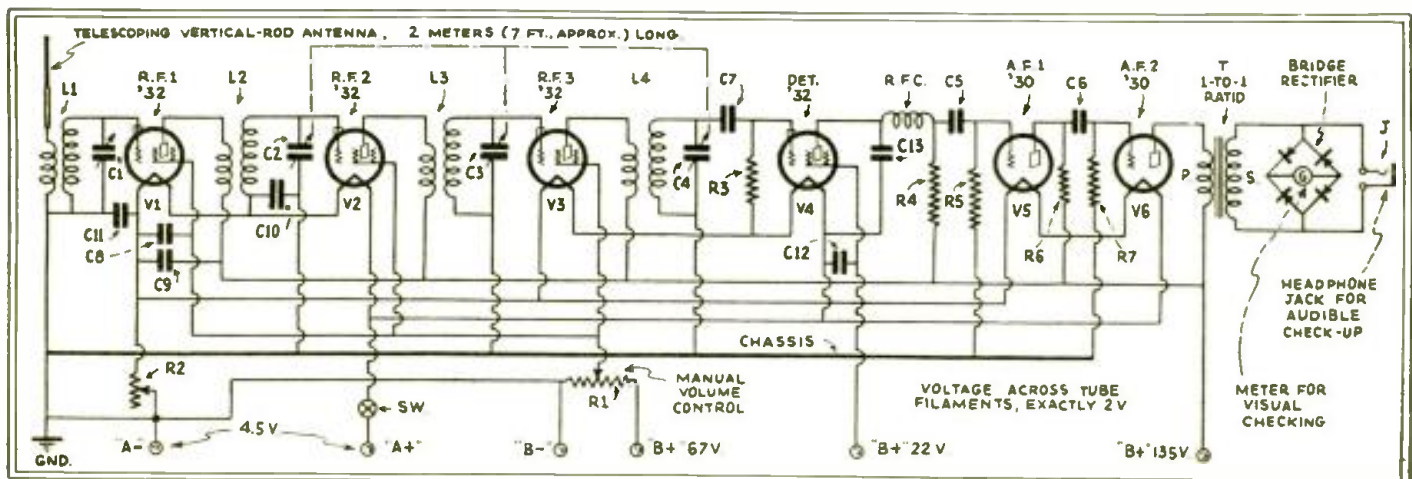

Fig. 1

Complete schematic circuit of the Tobe interference locator. The fidelity curve of this receiver is almost perfectly flat from about 50 to 8,000 cycles; the greatest variation being about 5 DB.



Fig. B
Photograph of the panel of the interference locator showing the location of the controls

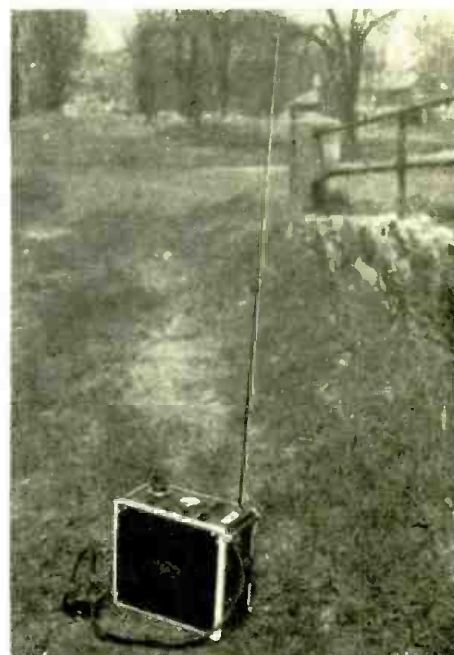

Fig. A
Photograph of the Tobe interference locator, model 232.

logarithmic response, and consequently meters were employed so that definite indications could be obtained.

Interference Field Strength

Public Utilities find that, in many cases, complaints are registered which state that reception cannot be obtained from distant stations. The interference man answering such a complaint can show the complainant, by the use of the interference meter to be described, that the noise only has an intensity of, say, 2 microvolts-per-meter, and that in his locality this figure must of necessity be tolerated. However, a survey made of the surroundings may show that if the complainant would erect his antenna at the side of the house or on the roof instead of in the back-yard, his interference would only be, for instance, 1 microvolt-per-meter. In this example his *program* pickup has remained the same as before, but the *noise* pickup has been reduced one-half. Thus the man sent out to investigate the complaint has been of real service, since he has determined, by the use of this instrument, the amount of so-called "permissible interference" allowed in the respective district, and has demonstrated the most desirable arrangement of the radio receiving equipment.

The field-intensity indicator consists essentially of a very sensitive light-

weight, portable unit equipped with a vertical-rod antenna. The sound output, besides being audible in a pair of phones, is indicated on a specially designed meter.

Program Field Strength

To make the interference locator complete, a calibrated signal generator must be incorporated so that the amount of interference, or the amount of signal strength from broadcast stations may be determined in terms of microvolts-per-meter.

The design of an interference locator to meet these conditions presents many interesting problems. First, the sensitivity must be extremely high, for, with a short rod antenna only six or seven feet in height, the pickup of the set must compare favorably with that of an up-to-date A. C. receiver operated on a long antenna. Then, the instrument used must have the smallest possible amount of background or tube noise so that reliable signal strength data may be obtained with the volume control fully advanced.

In the Tobe model 232 instrument design, a three-stage screen-grid T. R. F. amplifier circuit was adopted, using specially high-gain R. F. transformers; the volume control varies the sensitivity from 25,000 microvolts-per-meter to 0.5 microvolt- (Continued on page 490)



Fig. C
Exploring the territory, surrounding the antenna to determine its best location.

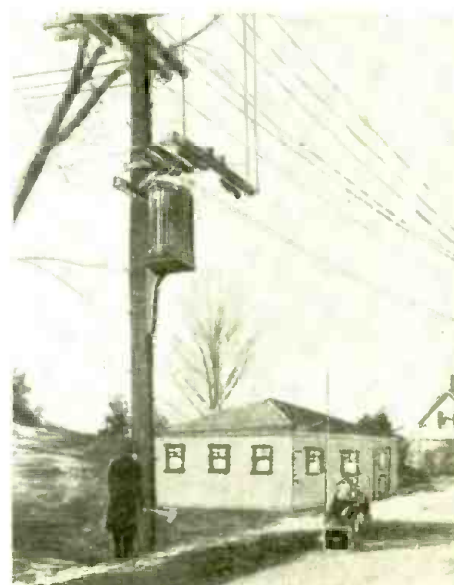

Fig. D
Localizing the source of interference near a pole transformer.

AN INTERFERENCE LOCATOR EQUIPPED WITH

1. A master switch for turning the instrument "on" or "off".
2. A variable control for adjusting the filament voltage of the tubes to the correct value.
3. A voltmeter for indicating tube filament voltage.
4. A meter switch for utilizing this voltmeter to read plate voltage.
5. A variable control for adjusting the volume of signal output from the instrument.
6. A dial for indicating the frequency to which the instrument is tuned. The frequency range of the instrument is from 530 to 1550 kc.
7. An intensity meter, having its scale divided into 75 equal spaces.
8. A switch for turning the internal signal generator "on" or "off".
9. An attenuator control, having its scale graduated in 100 equal divisions, for adjusting the output of the signal generator.
10. An auxiliary switch, dividing the range of the signal generator into three major divisions.
11. An output jack for connecting headphones, and the antenna jack for connecting the vertical rod antenna.

BUILDING AND OPERATING THE SUPREME "56" POINT-TO-POINT RESISTANCE TESTER

CHARLES PEPIN-DONAT*



Panel view of the tester. Turn the panel face down, and you have the sketch of Fig. 1.

DUE to the tremendous developments in radio receiving apparatus, which include the new R.F. pentodes, class A and class B amplification, muting circuits, etc., the average radio man finds it extremely difficult to keep up, not only with the technicalities of the trade, but, most unfortunate of all, with his testing apparatus. It seems that every new development along this line renders the already available testing apparatus obsolete, which is, of course, an extremely undesirable situation, both for the Service Man himself and for his customers. It has been, therefore, the aim of many manufacturers to place an analyzer on the market which, aside from including testing facilities for all the newest radio circuits, also embodies properties which are unlikely to render it obsolete as new developments in radio receiving apparatus are made. Furthermore it has been deemed highly desirable to make available the Model

56 Analyzer—to be described—in kit form, so that anyone may order the parts and easily build the analyzer with the aid of diagrams specially designed for the purpose, and be assured of a product as accurate in construction as the factory made unit.

Before going into details of the actual construction of the Model 56, it would be well to state the reasons

why this analyzer is unlikely to become obsolete. The properties which make this analyzer unique are its facilities for testing any radio circuit which may be encountered. The Model 56 has no push-buttons; but instead, is provided with a number of pin jacks which may be interconnected with suitable test leads to obtain any reading in any radio circuit. Thus, radio-circuits designed for such tubes as the new 5-pin Wunderlich detector, in which the cap is connected to the cathode instead of the control grid, may readily be tested. Besides these advantages, the Model 56 Analyzer is designed to utilize all the advantages of the analysis of radio receivers by resistance measurements, a method which will undoubtedly be recommended in future radio service manuals. The use of the new universal 4-, 5-, and 6-contact sockets eliminates the necessity of two extra sockets, thus assuring compactness and simplicity of operation. The ever important price problem has also been

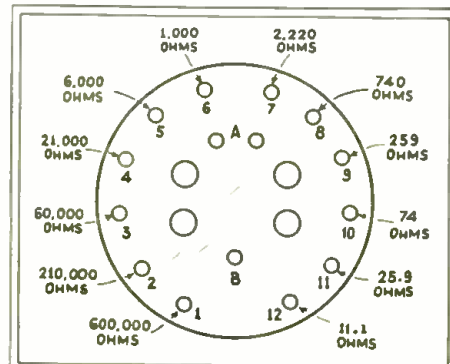

Fig. 3
Detail of the panel upon which the resistors are mounted. This panel is supported by the meter.

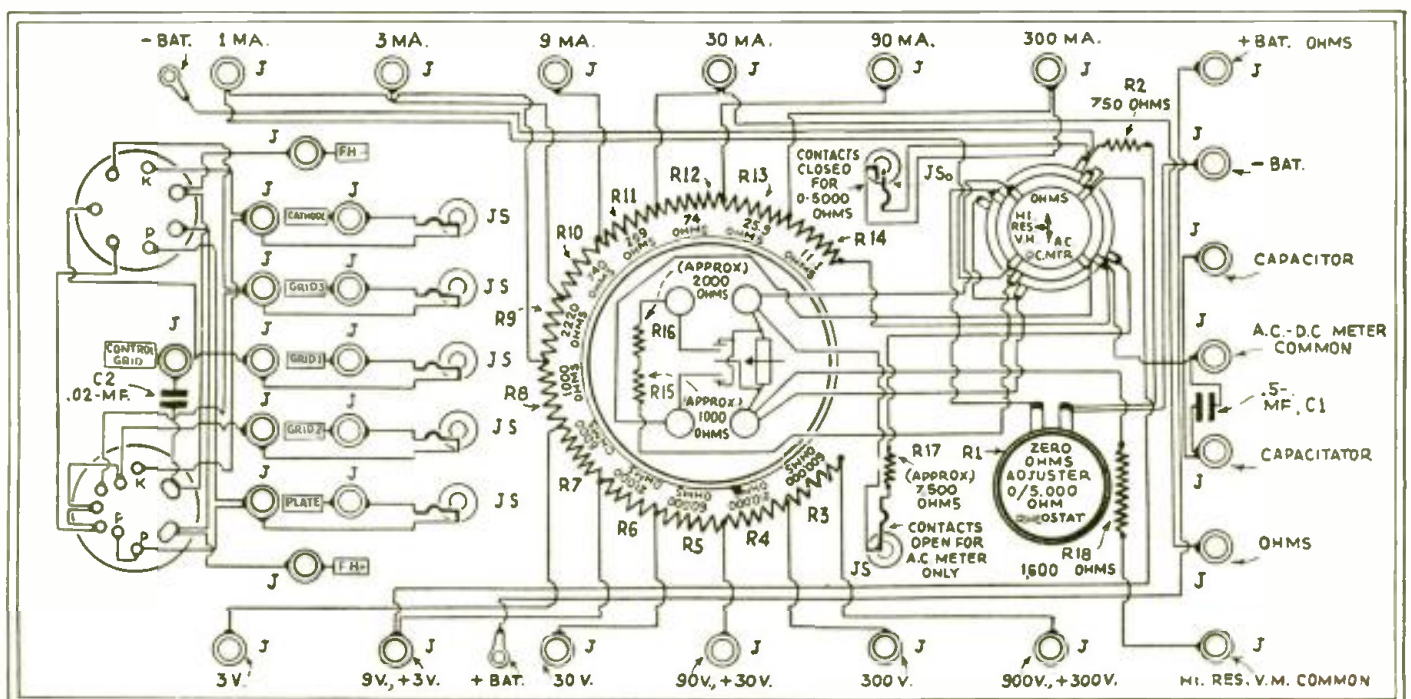

Fig. 2
Schematic circuit of the Model 56 tester. Voltage and current may also be measured. The battery connects, internally, to the two battery lugs.

DO YOU WANT TO BE MODERN?

● THEN here is a tester designed specifically for you. The complete parts may be purchased in a single unit for about \$48 with a drilled and engraved panel but not assembled or wired. This tester also measures voltages up to 900, A.C. or D.C.; and current to 300 ma., A.C. or D.C. A very complete resistance-measuring range is included, of course.

A REAL TESTER FOR THE MODERN SERVICE MAN

solved, inasmuch as the Model 56 provides super-modern and futuristic facilities for a price within the reach of all.

The most important and unique feature of this analyzer, however, is its patented *multimeter*. This is the only successful and accurate meter on the market which will read A.C. and D.C. potentials and currents on the same scale. The advantages are obvious: it offers complete protection against a reverse movement of the needle (due to the application of a reverse potential); the elimination of a "reverse potential" switch and the simplicity of scale readings along with the multi-ranges offered for potential, current and resistance readings, render the Model 56 worthy of the name "all-time" analyzer.

Description of Tester
The Model 56 analyzer is designed

to meet all modern requirements in a radio tube socket tester. It is equipped with sockets for the accommodation of all commercial 4-, 5-, 6-, and 7-pin radio receiver tubes without adapters. An 8-wire analyzing cable is used, terminating with a 6-pin analyzing plug with a center contact for connection with a 7-pin adapter. The control grid lug is extended from the cable at

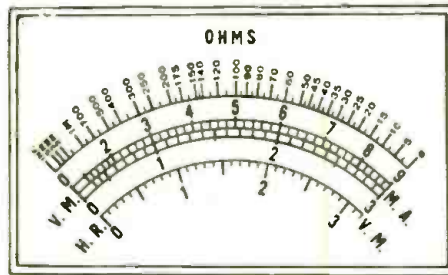

A line-drawing of the scale of the special meter.

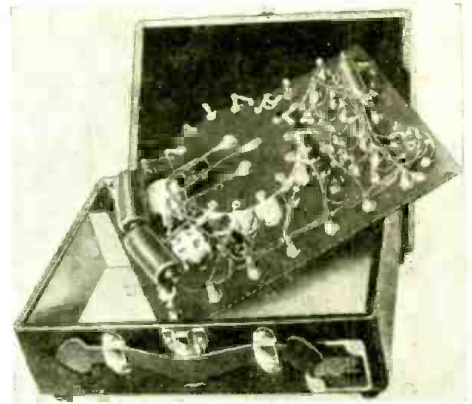

Internal view of the Model 56. Note the location of the multipliers.

the top of the plug by means of an insulated flexible conductor so that "top capped" tubes of any size can be accommodated.

Each of the analyzer cable circuits is connected to pin jack terminals on the analyzer panel so that the meter can be connected across any pair for potential or for resistance measurements. The cathode, plate, and the three grid circuits are each provided with two such pin jack terminals with switches between the pin jack pairs, so that the meter can be connected into any of these circuits for current measurements, or the self-contained battery can be connected into any of these circuits for tube tests.

The meter is of the rectifier type, utilized in a patented circuit which provides compensation for temperature variations and enables all A.C. and D.C. readings on a single scale. The meter has a basic sensitivity of 360 microamperes which enables the calibration of resistance-indicating

(Continued on page 495)

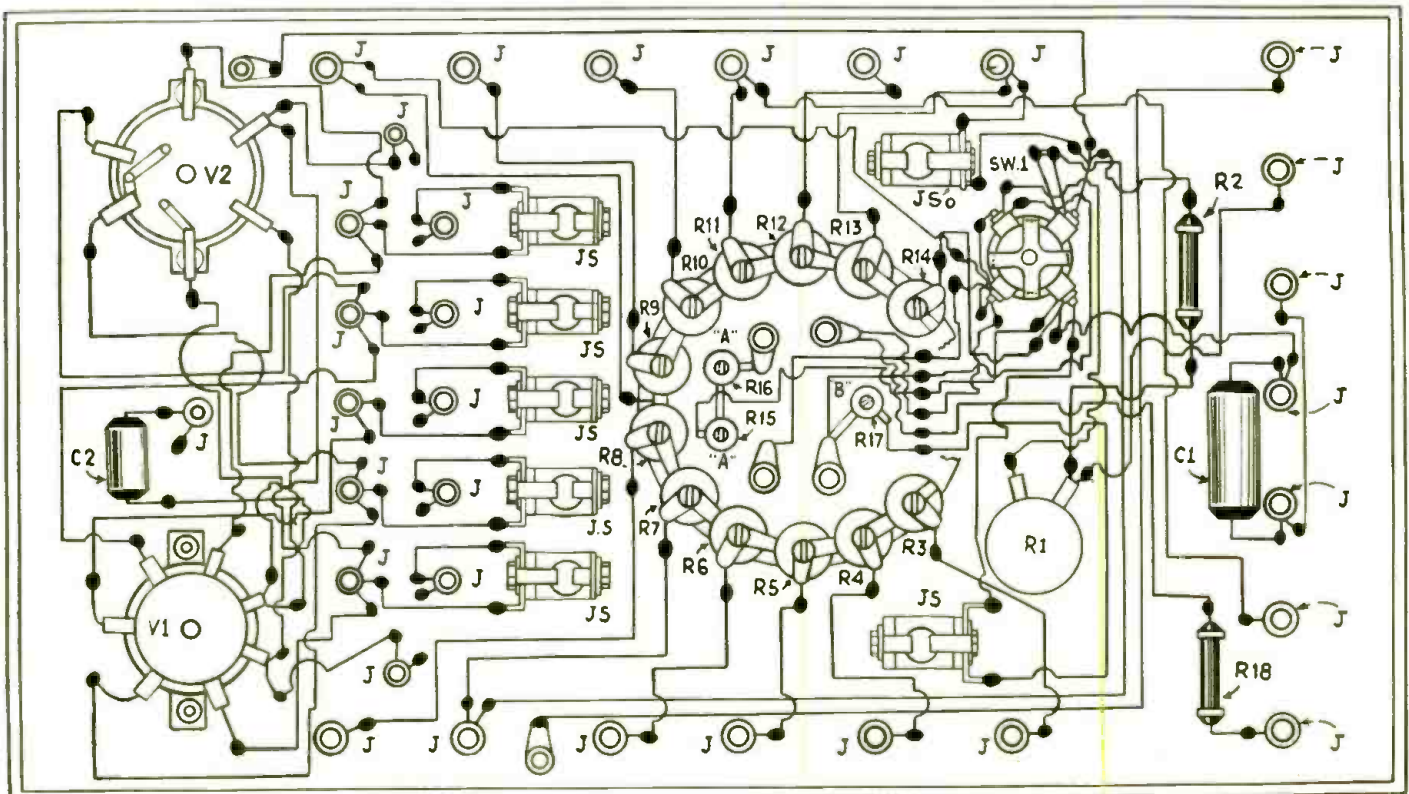

Fig. 1

Pictorial view of the tester. It may be wired exactly as pictured here; refer to the schematic circuit of Fig. 2 for additional data

BUILDING AND OPERATING

THE A. C. METERLESS TUBE TESTER

A description of the A. C. model of the Meterless Tube Tester described by the author last month

SOL. D. PRENSKY*

TO BRING simplicity back to testing circuits is the job for the meterless tube tester. Beautifully simple; able to meet any threat of more new tubes, and low in cost, this outfit should appeal to anyone interested in testing tubes. The original model (simple model), presented in the January issue of RADIO CRAFT was an elementary model operated by two dry cells and a 4½ V. "C" battery. The model presented here is A.C. operated in conjunction with a 7½ V. "C" battery, the drain on which is very small. It will test forty types of tubes in a simple manner, and give dependable results. When new tube numbers arrive, they may be taken care of by simple additions to the chart, which will be explained below. Although this tube tester is a unit in itself, it will be found to be a useful and fitting companion to a "point-to-

*Instructor in Physics, New Utrecht High School.

point" set tester for resistance servicing. And all at a cost of about \$8!

Testing Principle

As explained in the previous article, we are using the fundamental circuit of a simple, audio-frequency oscillator, reproduced again, for convenience, in Fig. 1, where the primary of the audio transformer, used as a tickler, causes the tube to produce an audible note, i.e., to oscillate at audio frequency. This circuit, as shown in Fig. 2, is so arranged that inserting any one of the types of tubes listed, in its proper socket, will cause an audible note to be heard in the phones. The variable factor, which gives us the scale for the worth of the tube, is the relative amount of plate voltage which must be applied to the tube in order to first hear the note. This factor is controlled by potentiometer R3, across the 7½ V. plate supply, by means of which the voltage is increased from 0 to 7½

V, as the R3 dial is rotated from its 10 to its 1 reading.

Under the conditions fixed for each tube, we find that for any given type, as a tube becomes less and less satisfactory, it requires more and more plate voltage to start it oscillating. All that is required, then, to give a valid test on the condition of a tube, is to prescribe the limits of the R3 dial reading—between which a good tube works; and similarly, the limits for weak tubes. Any tube requiring still more plate voltage (that is, a still lower reading of R3) can be branded as unsatisfactory.

In general, it has been found that most good tubes start working between 10 and 5 in this circuit. The chart explained below gives the accurate limits.

The function of the other parts in Fig. 2, is to fix the conditions for operating each tube. Thus, we have rheostat R2 and fixed resistance R1 for the filaments; the various switches, which

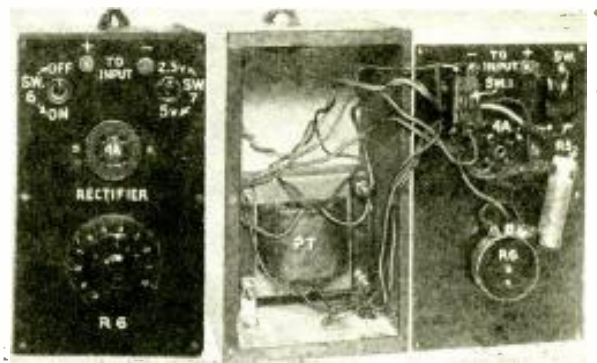

Fig. C
Panel and internal views of the auxiliary tester for rectifier tubes. This unit is not absolutely essential.

FEATURES OF THE METERLESS TUBE TESTER

- MAY be fully constructed at home by anyone for about \$8.00; It is simple to operate and positive in its results; It completely tests more than forty different tubes; It uses absolutely no meters of any type, therefore there is nothing expensive that can burn out through misuse; the circuit is fundamentally sound—there is nothing tricky or erratic about it to cause instability. Build, and see for yourself.

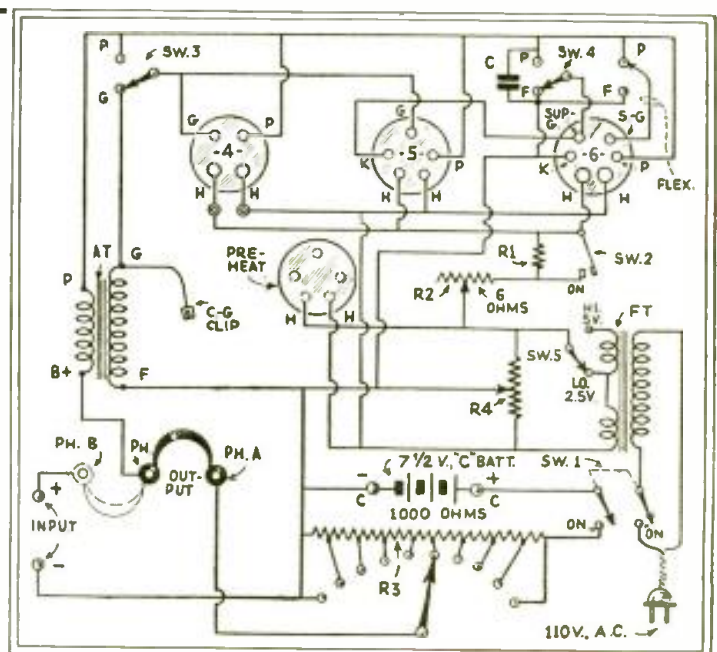

Fig. 2
Schematic circuit of the A.C. Meterless Tube Tester. Above, the left position of R3 is 10 and the right, 1, on the dial.

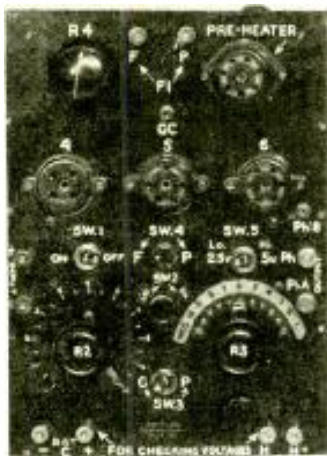

Fig. A

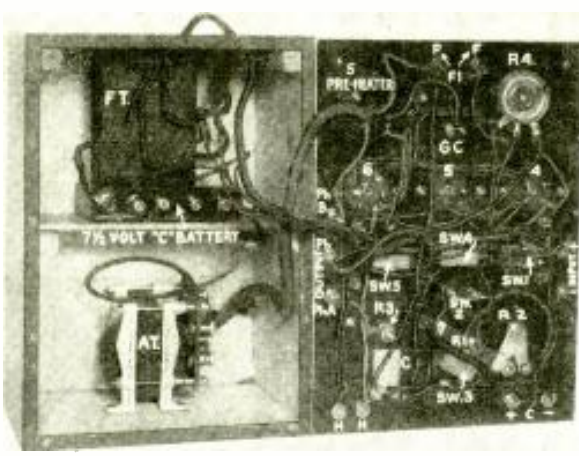

Fig. 8

Panel and internal views of the tester. The unit may be made portable by placing a handle on the side of the case. It is hidden from view in Fig. 8.

are explained below; and R4, used to center-tap the filaments of non-heater tubes to eliminate any A.C. hum. It was not considered advisable to incorporate a 7-prong socket, since a 7-to-5 adapter will take care of these tubes when needed. A pre-heater socket is included for convenience.

It is important to note that we are not judging a tube by its ability to oscillate. We are noting, rather, how well the unknown tube works in comparison with a good tube of that type working under similar conditions. So that if a certain tube is, by its nature, a poor oscillator, all other good tubes of that type will be rated "good" if they oscillate within the limits set for them, while the poor tubes will be "shown up" by comparison.

In other words, we are using a comparative method—a method which approaches the ideal more closely with better results than can be obtained with any other kind of tester on the market—of testing a tube to see if it will work by putting it to work. This basis, surely, has more merit than the basis of testing a tube for one arbitrary characteristic (selected from its many characteristics), namely the reading of its filament emission, which is employed by so many reasonably priced testers now on the market. Notwithstanding its low cost, then, we are able to use

the Meterless Tube Tester to hear our tube operating, rather than read by a meter how it should operate. The results of a great many tests which were run to check our results against those of commercial tube testers show the readings of the meterless tester to be valid and trustworthy. In fact, among the scores of cases where both results tallied, a few instances turned up where tubes had to be tried out in actual sets to settle the difference. The majority of these border-line cases completely vindicated the results of the Meterless Tube Tester.

Construction Notes

The construction is very simple and only a few pointers need be given. The panel parts are first mounted and wired separately. In the photograph shown in Fig. A, the panel is in two parts which are held together by two strips—because it is convenient to use the control panel (lower half) which is available as a unit, with all parts mounted. This leaves the upper half for the sockets and center tap adjuster, R4. However, any 1,000-ohm potentiometer (tapped or untapped) and any 6-ohm rheostat may be used instead, though this will make the chart given herewith meaningless, because the dial readings will be changed, and another chart will have to be prepared in accordance with directions explained later.

The same situation applies to the (Continued on page 492)

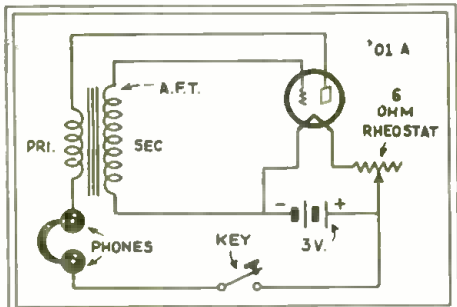
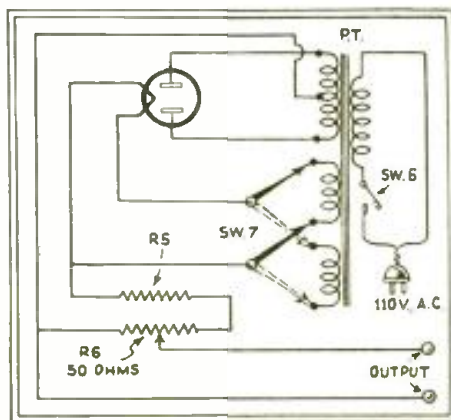

Fig. 1, above

Fundamental circuit of the tester. It is nothing more than the regenerative hookup which, slightly modified, was used so extensively in early radio receivers.

Fig. 3, right

Schematic circuit of the separate unit used to test rectifier tubes. This unit is not absolutely essential. The upper "output" post is positive.



Type of Tube	All Switches Normal (N) unless otherwise noted	Setting of RE	Reading of AS when Tube is		
			Good	Wear	Reject Below
'01A	N - Normal SW. 1 On SW. 2 On SW. 3 to 1 SW. 4 to 2 SW. 5 to Le(2-5) Pl. to P	7.5	10-6	4-3	3
'10	SW. 5 to H(5v)	6	10-6	4-4	4
12A	2	7.5	10-6	4-4	4
'22	SW. 3 to P	6	10-6	3-2	2
'24A	SW. 3 to P	7.5	10-6	4-1	3
'28	N	6	10-6	4-4	4
'27	N	7.5	10-5	4-3	3
'30	SW. 2 Off	2	10-6	4-4	4
'31	SW. 2 Off	2	10-6	5-6	4
'32	SW. 2 Off SW. 4 to P	2	10-6	4-3	3
'33	SW. 2 Off SW. 4 to P	2	10-6	4-3	3
'34	SW. 2 Off SW. 3 to P	2	10-6	4-3	3
'35	SW. 3 to P	7.5	10-6	4-3	3
'36	SW. 5 to H1 SW. 3 to P	1	10-6	4-3	3
'37	SW. 5 to H1	1	10-6	4-3	3
'38	SW. 4 to H1 SW. 3 to P	1	10-6	4-3	3
'39	SW. 5 to H1 SW. 7 Off SW. 3 to P Use 7-5 Adapter SW. 5 to H1 SW. 2 Off SW. 3 to P	4	10-8	2-1	1
41	SW. 5 to H1 SW. 2 Off SW. 3 to P	6	10-3	2-1	1
42	Use 6-5 Adapter SW. 5 to H1 SW. 2 Off SW. 3 to P	8	10-3	2-1	1
44	SW. 5 to H1 SW. 2 Off SW. 3 to P	3	10-3	2-1	1
'45	N	3.5	10-7	6-4	4
46	SW. 4 to P	3.5	10-7	6-4	4
'47	SW. 4 to P	3.5	10-7	6-4	4
49	SW. 2 Off SW. 4 to P	2	10-6	4-3	3
'50	SW. 5 to H1	6	10-6	6-4	4
51	SW. 35				
57	F1 to H	4.5	10-7	4-3	3
58	N	4.5	10-7	4-3	3
59	N	4.5	10-7	4-3	3
59	Use 7-5 Adapter	5	10-7	4-3	3
59A	SW. 2 Off	1	10-7	4-3	3
'71A	N	7.5	10-6	5-4	4
75	SW. 5 to H1 F1 to H	1	10-6	4-3	3
89	SW. 5 to H1	1	10-5	2-1	1
LA	SW. 5 to H1	8	10-7	4-4	4
Numberless A (6 prong)	Use 6-5 Adapter	1	10-6	4-4	4

A complete tube table for the tester described here by the author. This table may be used by the constructor provided the parts used in its construction are exactly the same as given in the List of Parts.

CARTOON ADVERTISING FOR

FRED E. KUNKEL

NOT all advertising clicks, and many radio dealers are merely fumbling the ball trying to score a touchdown in their newspaper advertising. But one radio dealer, the Star Radio Company in Washington, D. C., has stumbled upon a productive medium which challenges attention and brings home the bacon in the shape of an enthusiastic consumer response, by using a cartoon advertising stunt, a 3-column by 50-line feature, run every other day as a means of winning attention for their advertising and to put their radio stores in the spotlight of public attention.

People want to be amused and entertained nowadays, even in their reading, and that humorous ads help to pay dividends in the radio selling game is aptly demonstrated by the comic strip advertising one sees coming into greater and greater vogue every day; for these ads not only attract attention, but they also invite reading. They cater to public demand for entertainment and that is why they are gaining in popularity every day.

"I believe that cartoon advertising attracts twice as much attention as ordinary advertising in which you simply show pictures of radios, because it appeals to the American sense of humor and somehow strikes a responsive chord," says N. N. Wallack, the manager. "People nowadays like to look at something funny and at least 500 out of every 1,000 people who glance over the daily paper, will read your cartoon advertisements. Although it may not give you immediate results, it is at least constructive advertising. Our idea is to make our name synonymous with radios, and so far this is the most effective way we have found.

"The main thing about cartoon advertising is that it gets your name well known about town, even though it may not result in direct selling. It has helped us. In fact, it has become so popular that I think in future years larger concerns than ourselves are going to use it.

"My first favorable im-

pression of cartoon advertising was when I started to smoke Murads, because with every package comes a little cartoon advertisement, which catches the eye, and the reading matter which goes with it just touches the spot, e.g., 'When you have accepted an invitation for dinner on Wednesday night instead of Friday—be nonchalant—light a Murad.' This attracted my attention right away, and every time I lighted a Murad I thought of the clever cartoon advertisements. So I decided to try it out in our advertising to see how it would work.

Advantages of This Type of Advertising

"There are many advantages in this type of advertising. For instance, a good comic strip will be read, laughed at and talked about by many people. Sometimes on a street car, one overhears people laughing about a funny ad, and quite often in a business office someone will say, 'Did you read that comic ad in the paper last night about the Star Radio Company?' And if not, this person will proceed to relate it, and there is a laugh from everyone.

"In this way our name is placed on the lips of a great many people, especially the majority of newspaper readers. When they see our advertisements so often in the papers, our name registers on their mind and they know we are a reputable firm, and that we are going to be in business for a long time to come, also that we are dependable and reliable. At the bottom of our ads, we

have a few words to say about our service or perhaps our tubes, and other accessories. We use less copy in cartoon advertising, and where it cost me \$100 heretofore to run an ad, now I can do it for \$30.

"We run these cartoons about three or four times a week, each of which is a different comic strip under the heading, 'Imagine My Embarrassment,' which uses the cartoon vehicle merely as an eye catcher and then, when the cartoon has been read, the eye naturally follows the

<p>Certified Radio Service Phone 146-1126 W. Annex E. Handy Map. Legn. Unit Conventional Licensed Operators—Radio Engineer Technicians Members of National Service and Radio Organizations 214 North 14th St.</p> <p>Most modern and fully equipped Service Laboratory and shop in the territory. Experienced in servicing over 1000 radio sets.</p> <p>Ten year free hour guaranteed factory service. Savings of one fourth to one half in service costs.</p> <p>WE GIVE A COMPLETE RADIO SET AND TUBE ANALYSIS FREE ANY PLACE IN CACHE VALLEY USING THE MOST MODERN RADIO EQUIPMENT TO BE HAD.</p> <p>Public address systems for every occasion.</p> <p>Offering for the first time in Cache Valley and vicinity a trade-in allowance on your old departed and outmoded tubes.</p> <p>We handle only the highest grade parts and tubes. Offering the only 90 day guaranteed service in the territory.</p> <p>There is no job too large or complex and for our service department we have service shops on every make of radio.</p> <p>We service any make of radio or radio equipment. Builders of every thing in radio. Complete radio library. Free literature trouble service.</p> <p>When in need of good radio service, if any kind call on or see one of our certified radio service dealers in your area or write or call us for the most prompt and honest service in Cache Valley.</p> <p>We charge the least to put tubes in your radio so that they last at the laboratory.</p> <p>CALL US ON HARRY TRIMMETS.</p>	<p>RADIO DON'T'S</p> <p>DON'T say profanity around your Radio. Read these Radio don't's.</p> <p>DON'T tamper with the wiring of your Radio.</p> <p>DON'T spill eggs and sugar on your Radio set.</p> <p>DON'T interchange your tubes.</p> <p>DON'T repair your microphone with poor atmospheric conditions.</p> <p>DON'T interchange your ground and antenna. A good antenna system and a good radio receiver make a good combination.</p> <p>DON'T have a poorly combined circuit.</p> <p>DON'T touch electrical conductors in your radio.</p> <p>DON'T repair good microphones with a poor antenna system.</p> <p>DON'T touch and set your radio in hot tubes are hot, they are very delicate and sensitive.</p> <p>DON'T remove modern reception with obsolete radio sets.</p> <p>DON'T cause surges in your radio power source. Might cause a burn out.</p> <p>Be sure your radio is well tuned.</p> <p>DON'T operate your radio without a good ground. It is essential for good reception.</p> <p>DON'T try to twist the knobs of your radio.</p> <p>DON'T install an antenna without a good lightning arrester. It protects your radio against lightning.</p> <p>DON'T fail to have a good voltage regulator on your set.</p> <p>DON'T tamper with your speaker or speakers and.</p> <p>DON'T trace the wires on your radio. They may belong to the building system of your set.</p> <p>DON'T change the wires on your speaker.</p> <p>DON'T bend and twist wires in your set.</p> <p>DON'T try to get more out of your set than what it can deliver.</p> <p>DON'T make metal connections into your radio.</p> <p>DON'T install your antenna parallel with power lines.</p> <p>Control a red or flame before you begin to smoke.</p> <p>Use an illegal advice or free. Call us.</p> <p>Be sure you put the right tube in the right socket.</p>
--	---

Above, an example of a form card distributed to residents of Cache Valley. Below, three examples of cartoon advertising that really bring results.

★ ★ | Imagine Your Embarrassment ★ ★

WHEN YOU MAKE A 90 YARD RUN FOR A TOUCHDOWN AND IT'S THE WRONG GOAL!

IMAGINE YOUR SATISFACTION when you come here and know you're in the RIGHT store to get real value in a radio. Our reputation for reliability is so important as the maker's reputation for quality—that a way it PAYS to go to—

STAR RADIO
409 11th St. N.W. 1350 F St. N.W.
3218 14th St. N.W.

★ ★ | Imagine Your Embarrassment ★ ★

WHEN YOU REMAIN ON THE 18 DAY DIET A DAY TOO LONG AND THE WIND CARRIES YOU AWAY!

IMAGINE YOUR PLEASURE when you take one of our new electric radios. On trial and discover that it SURPASSES in both tone and volume anything you've heard before at any place near the price. Deferred payments, of course.

STAR RADIO
409 11th St. N.W. 1350 F St. N.W.
3218 14th St. N.W.

★ ★ | Imagine Your Embarrassment ★ ★

WHEN THE NURSE BRINGS OUT THE WRONG BABY

IMAGINE YOUR EMBARRASSMENT, TOO, when the maid brings out word that the radio is dead just as you were expecting guests. But it needn't last—a phone call will bring an expert repair man on the run.

STAR RADIO
409 11th St. N.W. 1350 F St. N.W.
3218 14th St. N.W.

THE RADIO SERVICE MAN

The most remunerative form of advertising has long been a matter of dispute. In this constructive article, the author presents some interesting views on cartoon advertising.

rest of the ad and the reader catches the message such as:

IMAGINE YOUR PLEASURE when you take one of our new radios on trial and discover that it **SURPASSES** in both tone and volume anything you've heard before at anywhere near the price. Deferred payments, of course.

IMAGINE YOUR EMBARRASSMENT, TOO, when you overhear friends commenting on your old battery set. But also imagine your happiness when you replace it with one of our modern radios—why not do it **TODAY?**

IMAGINE YOUR SURPRISE when you get the bill for the repairs we make and find it's even **LESS** than you expected. Expert workmanship at no extra cost is a certainty when you phone and get us!

IMAGINE YOUR EMBARRASSMENT, TOO, when the maid brings out word that the radio is dead just as you were expecting guests. But it needn't last—a phone call will bring an expert repair man on the run.

IMAGINE YOUR SATISFACTION when you come here and know you're in the Right Store to get real value in a radio. Our reputation for reliability is as important as the maker's reputation for quality—that's why it **PAYS** to go to The Star Radio Co.

IMAGINE YOUR PRIDE when the guests at your party comment on the fine radio you got here. One of our modern cabinet models will lend beauty to your home and add hundreds of happy hours to your life.

"The most important thing in all this advertising is that our name appears on each ad in such a way that it is the first thing a person sees and is the first thing that registers on his mind. He is bound to see it even before the comic strip is read. My personal opinion is that an ad, whether a full page or a half page, is ab-

solutely fruitless and useless without the firm name in prominent letters where it will be seen the first thing.

"I believe that ninety per cent of one's business is done through advertising, and although it may not produce direct results, immediately, eventually you will become so well known by the public that your store will become the logical place to buy a new radio or get a radio repaired, and you will get more than a fair share of the business to be had because of such sales promotion and publicity.

"We have tried all types of advertising but none of them have been so effective as newspaper advertising. It reaches more people, and where an ad is run 3 or 5 times a week, the name of the advertising firm becomes impressed upon the minds of the public. Billboard and novelty advertising did very little for us. It was not only expensive but a waste of money, so now we use the newspapers exclusively.

"Cartoon advertising suits our particular needs more than any type of newspaper advertising and we intend to use it for a long time to come. People are sick and tired of looking at photographs of radios because they are the same old things, but everyone enjoys reading a new comic strip of some kind.

"Then, too, there are so many radio stores in this city that it is difficult to offer anything unusual or interesting—besides price—through advertising. We all handle the same radios, the same accessories, so unless you can offer the public something different and clever enough to make them remember you, you are lost, for people will not come to you. We have solved this problem in cartoon advertising which is constructive and always provokes a laugh. It has succeeded in putting our name on the lips of more people who will be interested in radios—eventually, if not now."

Editor's Note

How many of you dealers or Service Men have experimented with advertising? If you have a "go-getter," let us know. Space rates paid.

Imagine Your Embarrassment

WHEN you are so interested in reading this feature you bump right into the chap you had your stenographer tell you were out of town!



AND—Imagine Your *DELIGHT*—when we tell you we're going to run this feature in these columns every other day from now on! That is just what we're going to do—and if you miss a single issue—IT'S YOUR OWN FAULT!

The Largest
Radio Service
Department in
Washington



STAR RADIO CO.
WASHINGTON'S LARGEST RADIO STORES
409 11th ST. N.W. 1850 F ST. N.W. 3216 14th ST. N.W.
NEXT TO PA. AVE. IN THE NATIONAL BUILDING PLAZA
PHONE 6120

Phone
District
4700

A follow-up cartoon which is bound to focus attention on the comic strip.

Do you know where to advertise for best results? Do you know what to expect from good advertising? Do you know the best form of radio advertising? Can you make good advertising pay for itself? These and other vital questions are answered in full by the author of this much-needed article. What do you say?

CONTROLLING FIDELITY WITH THE 58 TUBE

EDGAR MESSING

DURING the last few months, new tubes, notably the 50 series, have been presented to the set designer, experimenter, and home builder to play with. Of these, the 58, perhaps the most interesting, was more or less expected ever since the 239 was introduced; but an unforeseen difference between the 58 and 239 lies in the fact that the suppressor grid (between screen-grid and plate to prevent secondary emission) is not internally connected to the cathode, but is brought out to an extra prong on the base. This change, tube engineers claim, gives the tube added circuit flexibility and allows its adaptation to new uses.

The new and outstanding feature of the 58 is its application to control fidelity—automatically or manually. Such control is especially effective, and highly desirable in sharply tuned receivers such as the superheterodyne. Fig. 1 shows a curve taken by engineers to illustrate the effective audio output of the 58. And in Fig. 2 is shown the characteristic of this tube which accounts for this effect.

In Fig. 2 it will be noticed that variation of the suppressor voltage with respect to the cathode has the effect of

decreasing the plate resistance. Making the control or screen grid more negative, on the other hand, always increases the plate resistance. But when the suppressor is varied from 0 to -35 volts, and the control-grid bias kept constant at -3 volts, the plate resistance varies from 800,000 to 30,000 ohms—a change of about 26:1.

If, as is usual in superheterodynes, a tuned plate circuit is connected across the tube, Fig. 3, this variation of resistance entirely changes the character of the resonance curve of the circuit to accomplish tone control. Just what sort of change takes place, and how this change affects the set's quality, is easily determined by a simple graphical study of the circuit.

First, for the sake of simplifying the discussion, we draw the equivalent circuit of 3A in 3B where the parallel circuit of the tube is drawn instead of the more usual series circuit. The equivalent parallel circuit puts the plate resistance in shunt with a constant current generator, instead of putting it in series with a constant voltage generator—a perfectly legitimate procedure. For this equivalent circuit, the constant current generator must have a rating

$E_g G_m$; where G_m is the mutual conductance, as usual, and E_g is the signal voltage. For those who are mathematically inclined we may say that this value is found by setting up the conditions for both load current and voltage equal to that in the series circuit.

We shall for the moment consider G_m as being constant and investigate the influence of variations of R_p on the circuit.

The effect of the secondary circuit of 3A is simply to reflect additional resistance into the primary, so that if we consider the resistance of the tuned circuit of 3B as having been increased, no complications are introduced.

With these points in mind, we can proceed to draw our resonance curve—which is simply a curve showing the variation of output circuit impedance or voltage with frequency.

The curve for the impedance, Z , of the circuit will then be the resonance curve, or graph, Fig. 4, that shows the change with frequency of the impedance in the plate circuit. Since G_m is being considered constant, the current through the total load is constant, and any change in impedance means a change of voltage. Curve II, therefore, can be considered as the variation of

(Continued on page 498)

A NOVEL, PRACTICAL ADDITION TO A RECEIVER

- ARE YOU afraid of side-band cutting? If so, this article will tell you how to vary the selectivity of your set from the panel.

The results outlined in this article will be used in many commercial receivers in the future, and you should, therefore, get first-hand information on this vital subject now, by reading this article.

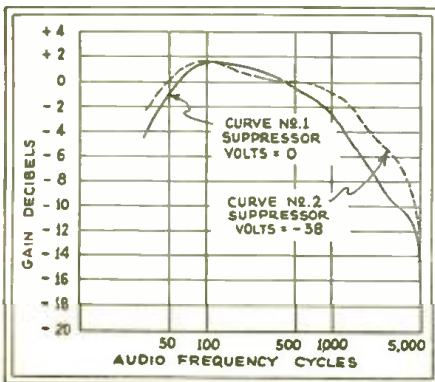

Fig. 1

Curves illustrating the gain in response due to change in suppressor voltage on the 58.

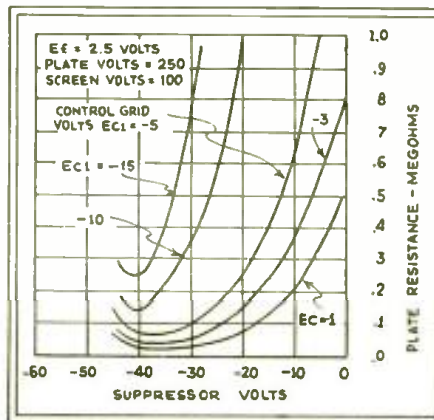

Fig. 2

Family of resistance curves of the 58.

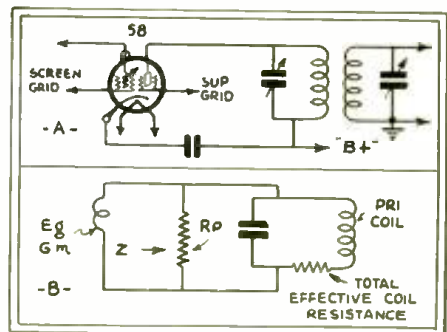

Fig. 3

At A, a circuit illustrating the connection of the plate circuit of the 58; and at B, its electrical equivalent. The plate resistance of the tube is shown in parallel with the load.

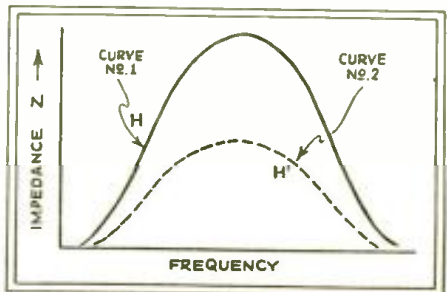
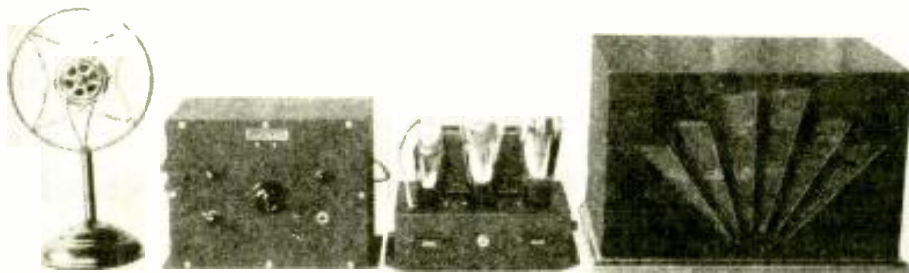

Fig. 4

Curves showing the change in impedance because of a change in drop in suppressor-grid voltage.



The complete Inter-Office call system. Left to right: desk microphone, control box, amplifier and dynamic speaker in individual cabinet. The speaker is decorative but not obtrusive and is readily placed on the top of a file cabinet or a small shelf, or mounted directly with a single large bracket.



Practising what it preaches: the telephone switchboard at the "Wholesale Radio" office, showing the "mike" directly at the operator's elbow.

MAKING MONEY WITH P.A. AMPLIFIERS

In this article, the third of a series written especially for Service Men who want more business, Mr. Short tells how to sell P.A. systems to business offices and factories. This is a practical application that deserves more attention than it is now receiving from Service Men.

HUBERT L. SHORT*

RADIO men in general are inclined to think of public address amplifiers and equipment in terms of crowds of people at public places. They usually stop their sales efforts after exhausting the possibilities of swimming pools, race tracks and similar places; yet there is a large and comparatively untouched field for business in ordinary offices and factories,—not big offices and factories, but just medium sized ones that exist by the thousand.

In many such commercial establishments the telephone operator is also the reception clerk, and finds it necessary to locate employees quickly when they are absent from their desks and therefore are not able to answer their own phones. Without a call system of some kind, the operator is forced to do a lot of frantic phoning from one department to another. Much time is lost and many tempers are tried, and the organization functions inefficiently. A simple P. A. call system, with a microphone next to the telephone switchboard, will soon pay for itself, in recovered time, in any office or factory in which different departments or units are out of sight of each other.

Sales Pointers

In approaching business houses on this matter, Service Men should emphasize the simplicity of the required equipment, its low operating cost, its

*Sound Engineer, Wholesale Radio Service Co., Inc.

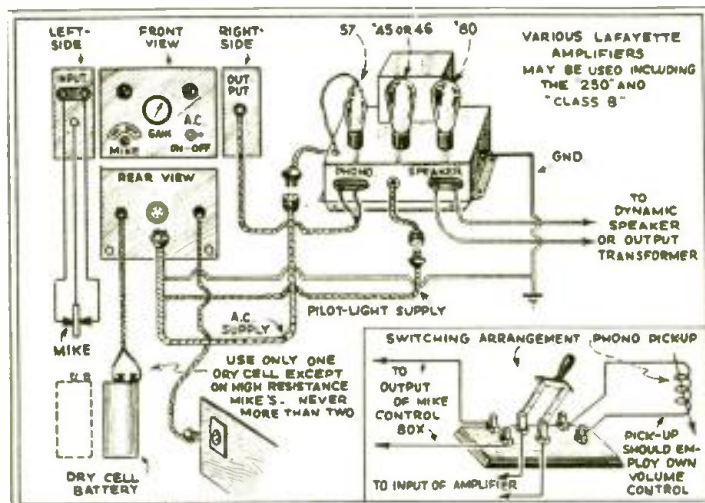

View showing cable connections from control-panel to amplifier to speaker.

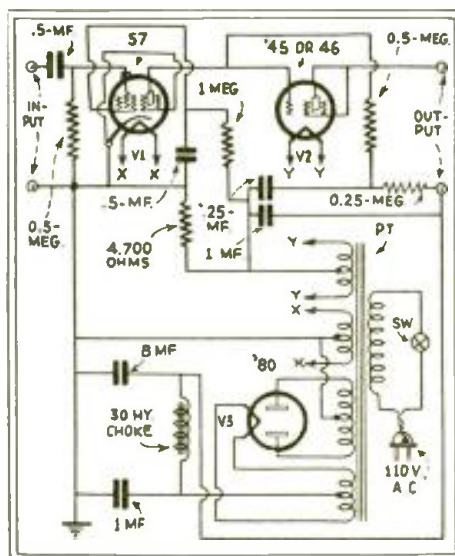

Schematic circuit of the direct-coupled amplifier.

reliability, and above all the fact that it does not need technical supervision once it has been installed. Since the microphone is left in one place, only a very simple control unit is needed; this, in turn, working into a fixed amplifier that will require only the occasional replacement of a tube. One or more loudspeakers may be hung in strategic places to cover large areas, depending on the construction of the particular office or the amount of noise in the factory.

It is also very easy to hook in an additional microphone for the personal use of the "boss," so that he can summon people to his desk, quickly, without picking up his phone and waiting for the office operator to answer. In many offices the desks of employees are within easy walking distance of the chief executive's, but not comfortably within direct talking distance. If the "boss" wants a person he must shout, stand up, and attract his attention by motioning, or call him through the switchboard. Frequently, the desired person, say a clerk or stenographer, has no phone of her own, which makes matters worse. A single loudspeaker in the center of the office will solve the whole problem very nicely.

In factories there is sometimes only a single telephone on a whole floor, with a number of men on that floor using it. If the operator wants a certain man, she can call him on the P. A. speaker and get him to the phone

(Continued on page 497)

BUILDING AND OPERATING A 3-TUBE, BATTERY- OPERATED, 7½ WATT, P. A. AMPLIFIER

Featuring a completely self-contained "A-B" current supply, simplicity of construction, low cost, and 7.5 amp. battery-current drain.

LOUIS GANCHER*

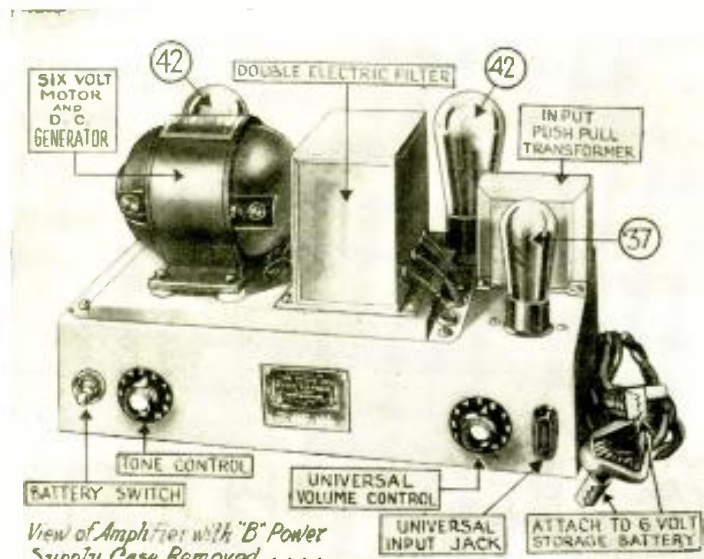

Fig. B

Photograph of the unique Coast to Coast amplifier with the generator unit attached.

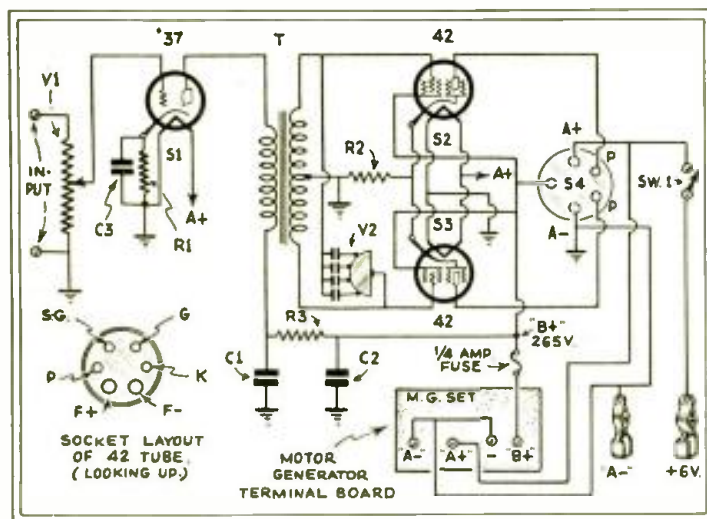

Fig. 1

Schematic circuit of the amplifier described by the author.

TO satisfy the requirements of average sound amplification coverage over an average city block from automobiles and sound trucks, this unique amplifier system has been designed and perfected. Its utter simplicity of design and attendant low cost brings this amplifier system within the financial reach of all,—its conservative outlay is no reflection on its unquestionable merit, for it will produce volume in a manner comparable with any other good amplifying device deriving its motive source from a conventional 110-volt, A.C. light socket!

Enterprising radio Service Men and dealers will quickly

see many ways in which this unique, low cost amplifier can be instrumental in adding to their weekly incomes, and yet only necessitate a minimum investment.

Undoubtedly, there is today, a substantial demand for a low-priced, fool-proof and non-techni-

cal automotive amplifier system . . . but this field has never been contacted. It follows, therefore, that you fellows who "get in on the ground floor" will reap handsome and substantial profits by renting and selling such installations.

Until the perfection of the "B" eliminator generator-motor herewith illustrated (See Fig. A), automotive amplifier systems entailed a considerable investment, either in the form of ever troublesome and expensive "B" batteries, which have to be continually replenished; or in the form of expensive rotary converters that produce 110-volts A.C., which impose an unreasonable drain upon automobile storage batteries. This new power supply is designed especially for this amplifier, and consists essentially of a motor and D.C. generator in one unit, the output of which is fed through a double filter system; it is highly filtered to such efficiency, that absolutely no ripple or hum is audible in the speaker. No shielding of power leads is required. Due to its inherent remarkable efficiency of 60%, only 5¼ amperes at 6 volts is consumed from a car storage battery to produce its output of 265 volts at 85 milliamperes. It is enclosed within a durable metal container measuring 5 x 9½ x 5¼ inches high, and weighs only 14 lbs. It is absolutely fool-proof, and requires no attention of any kind, its ball bearings requiring no oiling. This feature makes this device truly valuable to the novice who is not mechanically or electrically minded.

Inasmuch as this power supply actually "converts" the six-volt input coming from the storage battery to 265 volts of purely filtered D.C., it obviates the necessity for the use of a heretofore conventional tube rectifier and associated A.C. power pack which, of course, are attached to 110-volt, A.C. lines and which generally consist of a power transformer, filter condensers, filter chokes, rectifier tubes, etc. Naturally, in eliminating these parts, not only is their cost saved, but there is never present the difficulties attending the use of the rectifier tube, power transformer, filter condenser, etc. To fully protect the power supply, a ¼ ampere fuse is inserted in the "B+" 265-volt lead.

It might be stated here that this generator-motor is ideal for use, wherever A.C., D.C., or "B" batteries are not available, such as in outlying rural and mountainous districts, on boats, railroad cars, etc. As an instance, one of its interesting applications can be clearly illustrated by mentioning that this 7½-watt amplifier system can be installed on a horse-driven wagon, from which its owner is endeavoring to effect sales of fruits, vegetables, general merchandise, etc. An average size 100 amp., 6 volt storage battery can be conveniently carried on the wagon, and used all day; it can be recharged in the usual manner overnight.

(Continued on page 500)

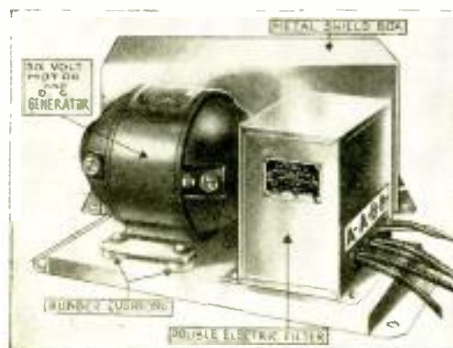

Fig. A

Photograph of the generator unit used so effectively in this amplifier.

*Pres., Coast-to-Coast Radio Corp.

THE ANALYSIS OF RADIO RECEIVER SYMPTOMS

OPERATING NOTES

INTERFERENCE ELIMINATION IN CAR RADIO INSTALLATIONS

Frank N. Mayer

A NUMBER of car-radio articles, especially on installation and ignition interference elimination, have been published in *RADIO-CRAFT*. The writer has read most of these, but believes he has a few tricks of his own that will be of some benefit to Service Men.

When car radio sets first came into my hands, the elimination of the ignition interference became the major problem for several reasons. First, daytime reception in the Black Hills of South Dakota is very difficult because the two closest broadcast stations are located about five to six hundred miles from this vicinity; and second, because of high mineral content and the shielding effect of the hills, a set must operate at nearly full volume for favorable reception.

Chevrolet cars gave us the most trouble. All of the ordinary tricks were tried but with little success. As a last resort, rebuilding the electrolock cable was resorted to and this did the trick.

In rebuilding the electrolock cable, it must first be removed from the car and taken apart, which is not such a difficult job. To remove the electrolock cable from the car, disconnect the wires from the terminal blocks at the upper end of the electrolock, remove the nut that holds the lock head to the meter panel, and the clamp that holds the cable to the dash.

To disconnect the cable at the lower end, remove the distributor head and fasten it up, out of the way. Next disconnect the cable from the circuit breaker housing by removing the oblong nut located inside the housing. The cable can then be removed from the car, care being taken to prevent its shorting to the starter terminal which is "hot" to ground.

After the cable has been removed, take out the retaining nut at the lower end to remove the stud bolt and insulation washers. Cut the locking washer off the bolt head and replace the bolt, guide shield, and washers back in the housing. Notice the above assembly so that difficulty will not be experienced in reassembling the cable.

Examination of the lock head (Fig. 1) will show that it is held together by a locking clamp located at A. Place the locking clamp in a vice and clinch it so as to force the clamp to open. After this has been done, knock the clamp off and slip the cable with its insulated terminal block, B, out of the

WHAT THIS DEPARTMENT IS FOR

It is conducted especially for the professional Service Man. In it will be found the most unusual troubles encountered in radio service work, written, in a practical manner, by Service Men for you.

Have you, as a professional man, encountered any unusual or interesting Service Kink that may help your fellow workers? If so, let us have them. They will be paid for, upon publication, at regular space rates.

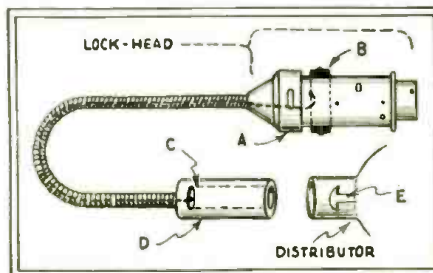

Fig. 1

Drawing of the cable assembly under discussion.

lock head. The cable can now be taken apart. Remove the insulated terminal block, B, from the upper end, pull the ignition wire out, and remove the shield inside the cable by cutting the wire that holds it in place.

In rebuilding the electrolock cable, use Belden shielded lead-in wire or its equivalent for the ignition circuit. First, connect the lower insulation block C to the shielded cable by enlarging the hole that the wire slips through, so that just the wire and the rubber covering will pass, thus preventing the shielding from coming in contact with the wire. Solder a small washer on the end of the wire and pull it into place in the block C, slip the assembly into the cable and fasten the top insulated block in place in a similar manner, being sure that the shielding does not cause a short in the ignition circuit.

The lock head may now be reassembled by placing it in a vice, forcing the insulation block, B, into place and driving the locking clamp, A, back into its original position; be sure to clinch it so that it holds the lock-head assembly together. Care must be exercised to prevent breaking the insulation blocks.

Before replacing the cable in the car,

it is best to test for grounds with a continuity meter between the ignition wire and the metal of the cable. The circuit should show open. (Some circuits ground the ignition wire when the switch is off.) Thirteen inches from the bottom end of the cable force an 8 in. length of bonding material into the ignition cable so it makes contact with the ignition wire shield. This is for grounding this shield to the dash.

The lower lock on the cable must now be reassembled. To do this, one new part, a locking washer, must be bought. Replace the parts in the same order that they came out, substituting the new locking washer for the discarded one. The cable is now ready to be replaced in the car. Mount the lock head on the meter panel, connect the wires to their respective positions, and clamp the cable to the dash. To replace the lower end, use a pair of gas pliers and a hammer. With the gas pliers grip the heavy metal shield at D, place it in position, and drive on the pliers until the cable end is in its correct position, that is, so that the locking washer engages with the stud bolt E.

After the cable has been replaced test it by starting the car then fasten the bond to the dash, preferably by soldering.

PHILCO MODELS 70 and 90

Joseph Riley

IN SOME instances, interference from airport radio beacon stations transmitting at or near 260 kc. may be experienced in some of the earlier Philco models 70 and 90 radio receivers.

At the time these sets were first put on the market these beacon stations had not been installed.

The interference may be readily eliminated by readjusting the I.F. compensating condensers at 250 or 270 kc. The Philco Model 095 oscillator may be re-calibrated at 250 by tuning in a broadcast signal at 750 kc.—third harmonic of 250 kc.—or 1,000 kc. for the fourth harmonic; substituting the oscillator for the antenna, and readjusting the 260 kc. compensating condenser of the oscillator until the signal is heard, and the output meter reads maximum.

KNOCKING OUT THE HARD ONES

Roy E. Jessup

ISUPPOSE that every Service Man has had his share of the hard ones. I have encountered some of these that are well worth writing about.

A local theater was having trouble with fading, Movietone reproduction. The trouble was readily attributed to

(Continued on page 493)

ZENITH MODELS 430 AND 440 12-TUBE SUPERHETERODYNE

(Dual reproducers, Zenith class AAA A.F. power amplifier; illuminated auto type full-vision control escutcheons; 540 to 1750 kc.—121 channels, including police band; silent tuning; A.V.C.; low-volume tone compensator; "shadowgraph" tuning; tone control; 110 V. or 220 V. line.)

The newest product of Zenith Radio Corp. is the model 430 receiver; equipped with the Zenith automatic tuning device, it is the model 440. The outstanding feature of this set is the "class AAA" system of A.F. amplification used.

Tube Type	Fil. Volts	C.-G. Volts	S.-G. Volts	Sup.-G. Volts	Plate Volts	Plate Ma.
V1	2.5	2.2	75	2.2	175	5.7
V2	2.5	4.5	75	4.5	190	2.3
V3	2.5	0	100	3.5
V4	2.5	2.2	75	2.2	200	5.5
V5	2.5	10	110	.3
V6	2.5	80	170	.8
V7	2.5	20	190	190	190
V8	2.5	-70	195	195	195
V9	2.5	-70	195	195	195	13
V10	2.5	-85	-85	22
V11	2.5	13	75	13	30	22
V12	5.0	360	65

Line potential, 115 V.; all controls maximum. All tube readings, except heaters, are socket to ground, using 1,000-ohms-per-volt D. C. meter.

Resistor R1, manual volume control, 0.5-meg., total, tapped at 0.4-meg. from ground end; R2, tone control, 0.5-meg.; R3, quiet-tuning control, 400 ohms; R4, R6, R10, 1,900 ohms; R5, 150 ohms; R7, R25, 1,500 ohms; R8, R17, 0.25-meg.; R9, R16, 24,000 ohms; R11, R12, 50,000 ohms; R13, 0.1-meg.; R14, R18, 500 ohms; R15, 8,000 ohms; R19, R20, 1-meg.; R21, 2,500 ohms; R22, 18,000 ohms; R23, R24, 400 ohms.

Condensers C1, C2, C3, tuning gang; C1A, C2A, C3A, tuning trimmers; C4 to C7, I. F. trimmers; C8, L. F. padder; C9, H. F. coupling condenser; C10, C11, C12, 2-mf.; C13, 0.1-mf.; C14, C15, C16, C17, C19, C20, C24 (25 cycles, 0.4-mf.), C30, C31, C35, 1-mf.; C18, .05-mf.; C21, C22, C23, C25, C26, C27, 8 mf.; C28, 0.5-mf.; C29, 25 mmf.; C32, C33, 500 mmf.; C34, .002-mf.

The condenser gang in this receiver is aligned at 1,500 kc.; the oscillator padder is aligned at 600 kc.

Field coil No. 1 has a resistance of 1,600 ohms; field coil No. 2 has a resistance of 2,000 ohms for section A and 3,500 ohms for section B. Choke Ch.2 has a resistance of 400 ohms.

There are no circuit changes or switches in this receiver for the reception of police calls. The tuning dial, itself, actually takes in the

police frequencies since it covers a total range of 540 to 1,750 kc.

"Shadowgraph" tuning is effected by means of a vane fastened to a meter movement connected in the plate supply circuit to tubes V1, V2, V3. The incoming signal causes this "meter" to move in the usual manner, thus twisting the vane so that it either obstructs the light and casts a wide shadow (off resonance), or permits the light to pass, casting a shadow no wider than the thickness of the vane (exact resonance of the tuned circuits).

Class AAA A.F. amplifier is the Zenith designation for a system employing three power tubes, each of which are biased as class A amplifiers, one of which is used to drive the other two in push-pull. If the grids were overdriven with the usual type of coupling transformer, having a high secondary impedance, between the driver and the output tubes and the push-pull grids overdriven, extreme distortion would take place. This difficulty is overcome by employing a special transformer of step-down ratio having larger wire and much less resistance in its secondary. This transformer is a very important part of the system. With such an arrangement it is possible to drive the grids of the power tubes positive without introducing distortion, because of the driver being a power tube and capable of supplying the necessary current on such peaks. The primary of this transformer has a higher impedance than is normally used, which value is somewhat reduced as the impedance changes in the secondary, when the power grids are driven positive. Its impedance, how-

ever, at the lowest value, still matches the driver plate circuit. It should be remembered that in an ordinary class A amplifier distortion enters when the grids are driven positive by virtue of the previous tube not supplying sufficient power for grid excitation of the output tubes. In other words, in class A, voltage on the power grids is available as long as they do not go positive. As soon as they are driven past zero in that direction the previous amplifier can no longer supply the necessary power.

Summing up the above, the triple A amplifier is a combination of both class A and class B. The exception being that the tubes are biased as class A, but by virtue of the power delivered by the driver and the special coupling transformer, sufficient power is supplied for the power tube to draw grid current and still prevent distortion as in the class B amplifier.

Many set analyzers will not accommodate the new tubes, consequently, all voltage readings are to ground. Thus, for instance, the actual voltage on the plates of the power tubes is 295 V.

The two reproducers are similar in construction but one is peaked at 90 cycles and the other at 70 cycles. (This is done to cancel the natural voice period of each reproducer.) The paralleled voice coils result in four times the power obtainable from a single reproducer, states the manufacturer.

An overall sensitivity of less than one-half microvolt-per-meter is obtained with an undistorted power output of 15 watts. The total line consumption at 115 V. is 125 W.

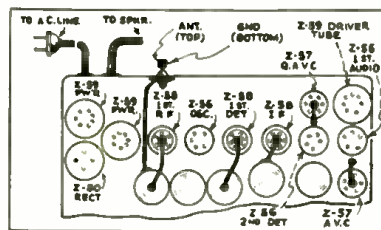

Above, Arrangement of the tubes in the "430." Right, Comparative figures indicating the effectiveness of A.F. amplifiers classes A, push-pull; B, push-push; pentodes in push-pull, and AAA, push-pull. Watts rating, respectively, 4.3 W., 0.8- to 24 W., 6.3 W., 14.2 W.

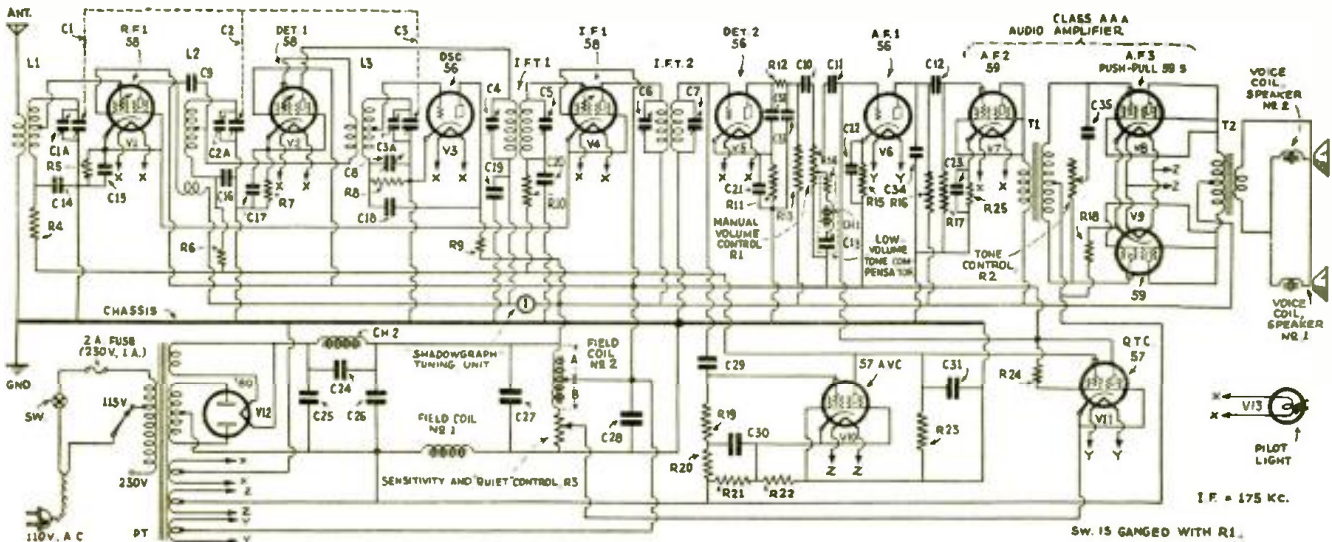
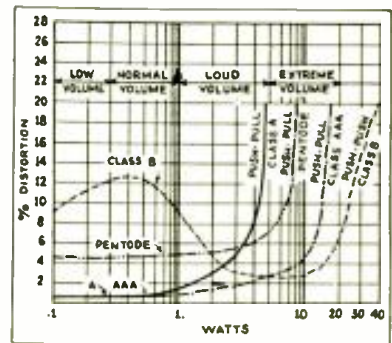

CROSLY "CHIEF" 12-TUBE MODEL 132-1 12-TUBE SUPERHETERODYNE

(Dual reproducers, class B push-push A.F. power output fed by a class A push-pull driver stage, meter tuning, A.V.C., tone control, static control.)

The Crosley Chief, 12-tube superheterodyne console model radio receiving set, is the most recent addition to the line. This receiver incorporates the model 132-1 chassis. Although incorporating a large number of tubes, the power line current consumption is held to a minimum by use of the new tubes which consume much less current than the older types.

Resistors R1A, R1B, 1.5 meg. (per section); R2, 0.4-meg.; R3, 80,000 ohms; R4, 0.15-meg.; R5, R6, 60,000 ohms; R7, 2,000 ohms; R8, 1. meg.; R9, 7,000 ohms; R10, 40 ohms; R11, 750 ohms; R12, R13, R24, 0.5-meg.; R-14, R23, 0.3-meg.; R15, 450 ohms; R16, 3 meg.; R17, 30,000 ohms; R18, 20 ohms center-tapped; R19, 3,500 ohms; R20, 6,000 ohms; R21, 10,000 ohms; R22, 5 meg.

Condensers C1 to C4, tuning units; C5 to C8, I. F. trimmers; C9, C25, C26, .02-mf.; C10, C11, C13, C14, C16, C30, C31, C32, 0.1-mf.; C17, C15, 4 mf.; C18, 150 mmf.; C19, 100 mmf.; C20, C23, .006-mf.; C21, C22, C28, 8 mf.; C24, .05-mf.; C27, .003-mf.; C29, 12 mf.

Tube Type	Fil. Volts	Bias Volts	S.-G. Volts	Plate Volts
V1	2.4	0.5	60	200
V2	2.4	2.5	60	200
V3	2.4	13.5	—	170
V4	2.4	0.5	60	200
V5	2.4	8	165	220
V6	2.4	—	—	—
V7	5.6	23.5	220	200
V8	5.6	23.5	220	200
V9	5.6	28.5	—	405
V10	5.6	28.5	—	405
V11	2.4	77.5	—	70
V12	2.5	—	—	415

With a line potential of 117.5 V. the above figures may be taken as average readings; for "220 V." sets a line voltage of 235 is taken as standard. Bias (unless otherwise stated), screen-grid, and plate readings are taken between these tube contacts and the emitter; bias for V3, V5, V7 to V11, cathode to chassis.

Late chassis of this model have a 1,400-ohm resistor shunted across the visual tuning meter. Also, these later chassis may have two 1. meg. resistors (total) in the manual volume control circuit, connected from the moving arms to the ground ends of R1A and R1B.

The tuning meter of this receiver has a resistance of approximately 440 ohms and the deflection is approximately 10 ma.

The A. F. output of V6 actuates tube V11 which, in turn, controls the bias on the amplifier tubes for A.V.C. operation. By manual adjustment of R2 the degree of background noise is controlled to suit individual preference of sensitivity.

Note that the transformer secondary supplying tubes V1, V2, V3 is bypassed by a dual-section condenser, C30-C31. Another unusual circuit arrangement is the use of a double choke coil arrangement comprising Ch1-Ch2, and field coils 1 and 2. The first two choke coils are connected in the positive high-voltage lead in the usual manner, while the second two chokes, the field coils of the dynamic reproducers, are connected as an "inductive voltage divider," one terminal of the two coils in series being connected to the positive output of the regular filter system, and the other end being grounded to the chassis; the center-tap of these field coils supplies voltage to the screen-grids of V1, V2, V4, and to the plate of V5.

The tone correction furnished by C25-C26 applies equally to V9 and V10, the center-tap of these two condensers being grounded to the chassis. If any portion of the tone control R3, C24, becomes grounded the A. F. portion of the receiver will become inoperative as the entire tone control operates at the potential of the plates of V7, V8.

The manual volume control operates in the input circuit of the push-pull driver stage, V7-V8. The two sections of this volume control, R1A, R1B, operate simultaneously as a dual unit.

The first A.F. stage, V7, V8, is driven by a so-called split-diode circuit furnishing A.F. voltage from both the cathode and plate circuits, which are out of phase (in push-pull relationship).

The input circuit of V1 is preceded by a band-selector which must be carefully aligned in order to maintain the required degree of selectivity at all points in the tuning band.

The A.V.C. action is obtained through the voltage drop across resistor R4. There is an initial current flowing through this unit and the 5 meg. grid leak, R22, furnishing a normal bias for the R.F. and I.F. stages. The A.V.C. tube V11 is delayed by means of a positive potential on the cathode of about 60 V. When an R.F. signal of sufficient intensity is applied to make this A.V.C. tube (D.C. amplifier) draw plate current, its plate current also flows through R4 and furnishes an additional A.V.C. bias.

The "static" control is also connected to change the current flowing through R4, thus changing the initial bias on the controlled tubes, so that the overall sensitivity of the set is reduced.

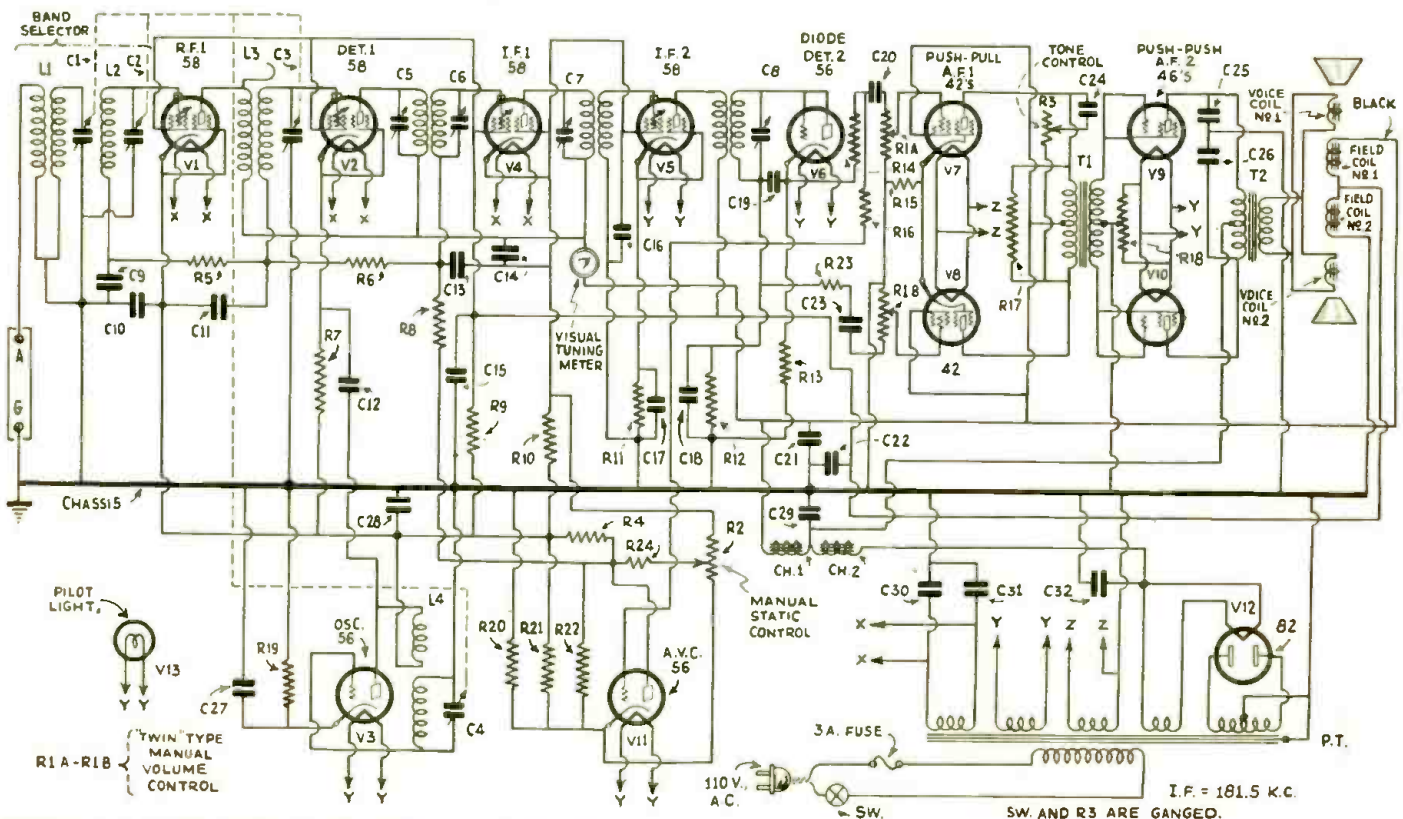

Schematic circuit of the Crosley "Chief" model 132-1, 12-tube superheterodyne. Note the unusual arrangement of the circuits of V7-V8, and also V11.

THE SERVICE MAN'S FORUM

Where His Findings May Benefit Other Radio Technicians

AN OPEN LETTER TO THE READERS OF RADIO-CRAFT

CONCERNING "ORPHAN" RECEIVERS

Judging from the thousands of letters we receive from Service Men all over the country, one of the biggest troubles in the service business at the present time is the unmarked radio receiver. Evidently there are hundreds of "orphan" sets that bear no identification of any kind, or at best have a single word on the dial escutcheon. Even the receivers of some large and reputable manufacturers are inadequately marked in that no chassis or model number is included.

One of the favorite tricks of small manufacturers of "stencil" sets is to mark the chassis "Manufactured under license by the Radio Corporation of America," with the first five words very small and the last four very large. The manufacturer's name is altogether absent, so the label means nothing.

What is a Service Man to do with one of these unbranded receivers if he gets it for repairs? The only thing he can do is to apply the usual tests with his analyzer. Sometimes the wiring is fairly simple and can be traced or guessed at without the aid of a diagram. If a condenser is shorted or a connection loose, the job is easy and the Service Man should consider himself lucky. However, if the wiring is all messed up, as it usually is in cheap midgets, or if resistors are open, it's just too bad. Unless you are willing to spend a whole afternoon tracing the wiring, you might just as well save yourself and the customer a lot of aggravation by frankly stating the set cannot be repaired.

If there is no name of any kind on the set, do not waste your time writing to RADIO CRAFT or the OFFICIAL

THE Official Radio Service Men's Association, sponsored by RADIO-CRAFT, invites all Service Men who are not members of the Organization to write for an application blank. It is the official service organization of this magazine and is main-



Official label button of the O. R. S. M. A.

tained solely for the interests of Service Men. Membership cards are issued upon passing a written examination which is forwarded by mail. Write for yours today. The O.R.S.M.A., 98 Park Place, N. Y.

cated, you can save time by writing to the firm directly. Describe the physical appearance of the receiver as closely as possible, as the manufacturer should be able to identify his own product. If the manufacturer himself pleads ignorance, because the set is an old one and no one in the factory remembers it (and this is very frequently the case, sad to say), you are out of luck, and so is the customer.

If the trouble in a particular set can be traced to a defective condenser a repair can sometimes be made because the capacity of filter and bypass condensers is by no means critical, and differences in capacity of as much as 100% have no apparent effect. However, if defective resistors are found, and they are not marked according to the R.M.A. standard color code, you will have to do some fancy guessing.

One thing that Service Men must remember is that the mortality rate among radio manufacturers has always been very high, and therefore information of many receivers cannot be obtained simply because there is no one to obtain it from.

We frequently receive complaints from Service Men that diagrams published in RADIO CRAFT OF THE OFFICIAL RADIO SERVICE MANUAL do not check with the actual sets in many respects. The reason for this is obvious: the manufacturers made changes during production and didn't bother to make a record of them. This may sound unlikely, but anyone who has worked in radio factories around the country will tell you that this is a comparatively minor transgression. The writer

(Continued on page 496)



"We are not magicians, and it is absolutely impossible for us or anyone else to identify—"

RADIO SERVICE MANUAL, giving the tube combination or a description of the chassis. We are not magicians, and it is absolutely impossible for us or anyone else to identify the instrument. We have thousands of diagrams on file, but we cannot dig up any particular hook-up unless we know its exact designation.

If there is a name of some kind on the chassis or the dial plate, but no model number, this is useful in that we can sometimes recognize the manufacturer from it. However, we cannot supply a diagram directly from this information; the best we can do is to refer you to the maker, or to write to him ourselves, for service data for future publication.

If the manufacturer's name and address are marked on the set, but no model number or name is indi-

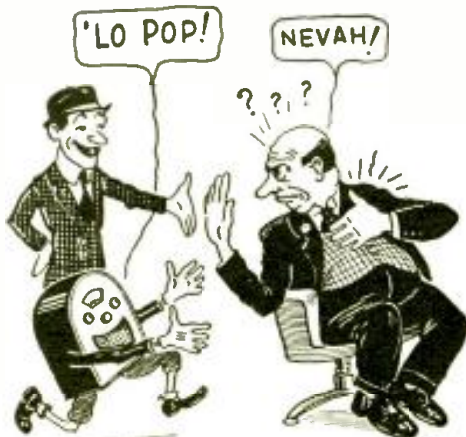

"If the manufacturer himself pleads ignorance because the set is an old one—"



"Evidently there are hundreds of 'orphan' sets that bear no identification of any kind—"

SHORT CUTS IN RADIO SERVICE

Prize Award

A POINT-TO-POINT RESISTANCE-TEST ADAPTER

AL. BEERS

IN regards to shooting trouble in radio sets via the resistance method, that is, a tube-socket to chassis test, I would like to submit the device I have been using for some time and found excellent (Fig. A).

The sketch, I believe, explains itself. First, it's speedy, and you not only have a complete resistance measurement, but a continuity test as well. You can use the same plug and cable that is used for the analyzer, and you do not have to remove the chassis; remembering, of course, to remove the tubes and disconnect the aerial, ground, and line plug. Second, it does away with that tedious job of probing around with test prods.

Of course, it is absolutely necessary, with this method, to have the schematic diagram on hand to know what you are reading. This is where the RADIO-CRAFT Manuals come in.

One can take a resistance test of a receiver, known to be in the proper condition, log it, and when you run into trouble in a similar receiver, make a comparison. I have yet to see this method of testing fail to disclose the trouble and centralize it. Personally, I am using it more than the analyzer, especially since the advent of automatic volume control.

Figure 1 shows the necessary material needed which consists of one inductance switch; seven switch points; one pin jack; and one Yaxley male, 7-contact multi-plug or one 7-prong tube socket, depending on the kind of receptacle one is using on the analyzer plug and cable.

The ohmmeter, B, and analyzer plug, C, are drawn in to clearly explain the diagram D. The dotted lines show the plate circuit of a set under measurement. Referring to D, it can be seen that it consists of two resistors, a speaker field, and one-half of the primary of an output transformer.

The entire unit may be mounted on a piece of bakelite 3 in. x 2 in.; or if one is rebuilding their analyzer or ohmmeter, it may

be incorporated in it. Because of the high resistors used in the late model receivers and the combination of resistances that will be measured via the tube-socket to chassis, an ohmmeter capable of reading several megohms is necessary. For this, refer to the July issue of RADIO-CRAFT, page 22, article by Bertram M. Freed and A. R. Gould.

The device looks somewhat shop-worn and I must confess I didn't spend much time putting it together, but was busy when I needed something to get a socket-to-chassis test quickly, and that's it.

Attached is a socket-to-chassis resistance chart of a Philco model 70 chassis. I believe if manufacturers would issue a like chart of their receivers it would be a great aid to the service field, for the Service Man would have something, then, for comparison. Line voltages in any city vary, and the voltage and current readings vary, but with the resistance chart, there would be no outside variations, for you have a fool-proof comparison.

Tube Pos.	H.	H.	G.	P.	K.	S.G.
'24 I.R.F.	200	200	0	6,250	280	2,500
'24 1 Det.	200	200	0	6,250	4,900	2,500
'27 Osc.	200	200	50,000	16,500	80	
'24 1 I. F.	200	200	0	6,000	280	2,500
'24 2 Det.	200	200	0	355,000	50,000	2,800
'47 Audio	0	0	250,000	6,500		6,000
'80 Rect.	6,000	6,000	300	300		

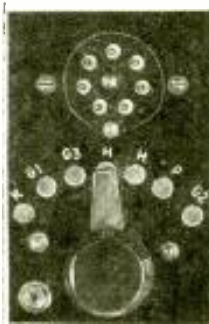

Fig. A.

At the left, photograph of the simple model using an external ohmmeter. At the right, photograph of the completed unit which has all parts mounted in a single case and incorporated with a regular set analyzer.

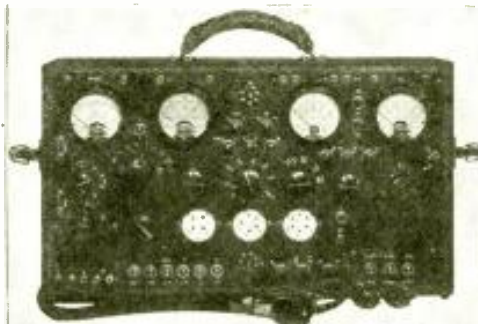

Fig. B.

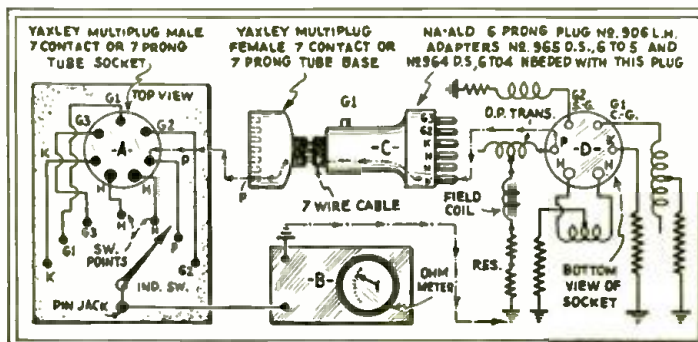

Fig. 1

Schematic circuit of the tester without the ohmmeter, as described in the text and illustrated in Fig. A, above.

\$10 for Prize Service Wrinkles

Previous experience has indicated that many Service Men, during their daily work, have run across some very excellent Wrinkles, which would be of great interest to their fellow Service Men.

As an incentive toward obtaining information of this type, RADIO-CRAFT will pay \$10.00 to the Service Man submitting the best all-around Radio Service Wrinkle each month. All checks are mailed upon publication.

The judges are the editors of RADIO-CRAFT, and their decisions are final. No unused manuscripts can be returned.

Follow these simple rules: Write, or preferably type, on one side of the sheet, giving a clear description of the best Radio Service Wrinkle you know of. Simple sketches in free-hand are satisfactory, as long as they explain the idea. You may send in as many Wrinkles as you please. Everyone is eligible for the prize except employees of RADIO-CRAFT and their families.

The contest closes the 15th of every month, by which time all the Wrinkles must be received for the next month.

Send all contributions to the Editor, Service Wrinkles, c-o RADIO-CRAFT, 98 Park Place, New York City.

A glance at the schematic circuit and also the resistor values in the service sheet will show the above about correct. Of course, the 0 readings mean full scale deflection. It might appear confusing to note the filament of the '80 shows 6,000 ohms; however, we are measuring to ground and not the 5-volt winding. The filament of the '80, being the high potential lead, goes through one choke in power pack, another choke in field coil, and a resistance network before reaching the common or ground point. Hence, the high reading.

Whenever I encounter trouble in a receiver and if I happen to have a resistance chart of same, I don't bother with voltage and current readings, but make a resistance test and compare. It has yet to fail.

The entire arrangement shown in Fig. 1 has been put in a single cabinet and is illustrated in Fig. B.

A short description to explain the resistance test end of the analyzer:

Looking at the photograph, in the center at the top and bottom are seen the two Yaxley male receptacles. The one at the bottom is the analyzer receptacle for voltage and current readings; the one at the top is the resistance receptacle. The same plug and cable are used for both tests.

Resistance measurements
(Continued on page 507)

THE RADIO CRAFTSMAN'S PAGE

The Bulletin Board for
Our Experimental Readers

HOME RECORDING AT HOME

Editor, RADIO-CRAFT:

I was much interested in the article in your April number, "Fidelity in Home Recording," by Mr. Saliba. For the past two months I have been spending considerable time experimenting in this highly interesting art. Having a limited amount of funds to spend at this time, it was necessary for me to use whatever equipment I had on hand, or else build it myself. And then I have to depend entirely on battery current, as we do not have access to the usual 110-volt A.C. (I live on a farm.)

I found directions for constructing a condenser mike, and I found a way to connect it to my five-tube Atwater Kent receiver so it would amplify ordinary speech or music through the loudspeaker with volume nearly equal to radio program reception.

My next problem was that of procuring a cutting or recording head. I removed the reproducing head from a phonograph tone arm, and took out the diaphragm, leaving the needle-holding finger in place. I then fastened a Baldwin speaker (with its diaphragm also removed) on the side opposite to that which holds the needle fixture, and with a small wire, connected the end of this needle holder which formerly fastened to the diaphragm, with the little vibrating plate which is found between the two coils of the speaker unit. The result, anyhow, is that vibrations in the unit which would have been causing the mica diaphragm to move, now causes the needle to vibrate. I found it necessary to provide a spring tension to the needle holder to control the needle's action. Perhaps I should have left one diaphragm in place to accomplish this.

I mounted this assembly on an iron rod about 15 in. long and placed it so it would ride the record disc properly.

The turntable is powered by a 6 V. motor having a rubber pulley bearing against the inner edge as the illustration in your paper showed.

For records, I use RCA-Victor blank, hard rubber discs, which are already grooved. I use the needles they advise for these discs. An ordinary needle would cut into the track.

To operate this device, I first make sure the voice or music comes through the loudspeaker in good

IMPORTANT NOTICE

In the interest of those readers who do not like to mutilate this magazine, we have asked some of our advertisers not to place coupons in their advertisements.

Instead of the usual coupons, you will find a number of convenient post cards inserted between the last page and the back cover of this magazine.

This new service will save you time and work. No need to cut coupons, nor is it necessary to hunt for and address envelopes. Moreover the space for your name on a coupon is usually so small that the advertiser is often not able to make out your writing and then you wonder why you do not get the literature sent for.

Then, last but not least—the postage for a postal card is only 2c whereas a letter now costs 3c.

Read the advertisements and then turn to the page containing the special postal cards. Detach, fill out and mail the card of the advertiser whose literature or offers you want to have sent to you.

Mail your card today! Show the advertisers that you appreciate their cooperation and thoughtfulness.

RADIO MANUFACTURERS, NOTICE

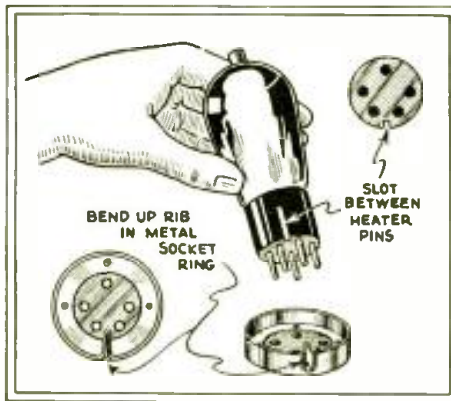

Fig. 1

This suggestion would go a long way toward reducing cursing—if the idea were adopted.

shape, and then I detach it from the set and connect in its place the two wires leading from the recording head. I start the needle in the groove, add about a one pound weight to the head right over the needle, and then start recording.

I found it required considerable adjusting of needle tension, motor speed, as well as proper microphone placing, etc., before the results suited me. My latest recording is quite good, I think. The voice comes out clear and understandable, even when played on an ordinary phonograph without electrical amplification. Per-

haps to one more advanced in this line, and with greater experience, my efforts would seem very poor, but I certainly am having a great time with the outfit.

HOWARD UNDERHILL,
Gibsonburg, Ohio.

YOU'RE RIGHT, KEEP GOING!

Editor, RADIO-CRAFT:

I wish to take the least possible amount of your time, and I'll try to be brief.

I constructed a so-called Tube Rejuvenator such as described in the October issue of RADIO-CRAFT, by Mr. Shaw. To my knowledge this outfit works very fine and I did increase the electron emission of many tubes of the oxide-coated filament type. On a Supreme 400-B, before the rejuvenation was tried, the readings were 14, 14, 11, 11; and after, 34, 38, 24, 28 for a 171A tube.

I happened to meet one service engineer from a big concern of Halifax, N. S., and he told me that I could not rejuvenate A.C. tubes, and I was killing myself so far as radio knowledge is concerned; and he told me that in front of some of my customers.

I'd like to hear from others interested in this rejuvenation process.

What do you think I should do about it?

J. MURILLO LAPORTE,
75 St. Francis St.,
Edmundston, N. B.

RE. "THE DECLINE OF RADIO SETS"

Editor, RADIO-CRAFT:

Your editorial, "The Decline of Radio Sets," in the November issue, is very timely—a true and just denunciation of damnably rotten design on most modern radio sets.

Here's my solution of the tube-socket trouble we are having. It will cost the set manufacturer about two cents per socket and the tube manufacturer about a quarter of a cent to accomplish it.

At the point of each tube socket, exactly between the heater prongs, a lip is punched up in the steel chassis which should extend into the zone of the tube base 1/16 in.

The tube base is then slotted 1/16 in. deep just between the heating prongs up the side, as shown in Fig. 1.

W. W. BRACKENRIDGE,
Harrison, Ohio.

RADIO-CRAFT KINKS

Practical Hints From Experimenters' Private Laboratories

Prize Award

SAVING THAT SOLDERING IRON

N. E. Folen

IT SO happens that the line voltage supply in Portland homes is one hundred and twenty volts, or over. The same may be true of other cities in the United States, therefore, this article.

I use one of the resistances from a Philco "A" and "B" eliminator, as per the attached sketch of Fig. 1, to save my soldering iron tips.

"Low charge" puts about 90 volts to iron; "Medium charge" puts about 100 volts to iron; "High charge" puts about 110 volts to iron; "Boost charge" puts about full line voltage.

The iron can be left on all day on "low" without hurting the tip. It then takes only about one-half the time to get soldering heat than it would if the iron were cold.

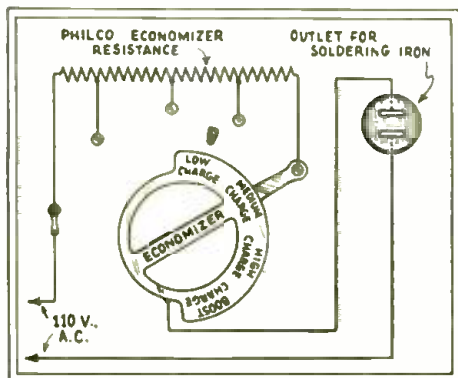

Fig. 1

A series resistor made from a Philco "A" and "B" eliminator makes a good regulator for the soldering iron that always gets so hot.

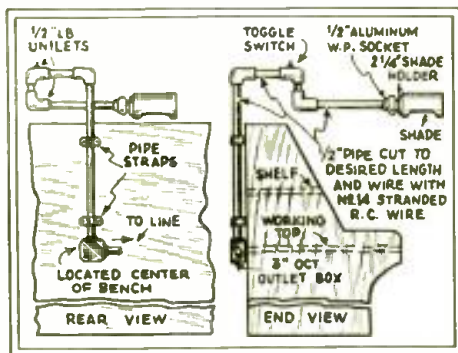

Fig. 2

Proper illumination is very important. You need it while you are working, but, for some reason, never build anything to have it when you're not working.

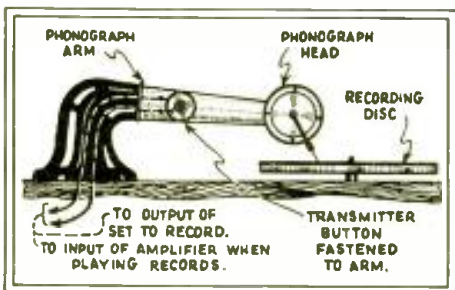

Fig. 3

By placing this microphone, preferably of the lapel type, in the tone arm of the "gramophone," the vibrating air actuates it giving electrical reproduction.

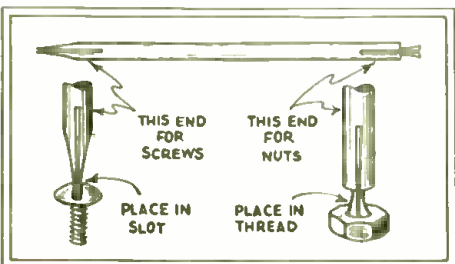

Fig. 4

Here is a small but handy device that every Service Man or experimenter needs—and needs badly—at some time or other. If you must build it eventually, why not now?

AN EMERGENCY PHONO PICKUP

W. D. Gibbs

WHEN an electric pickup is needed, and none is available, I have found that the arrangement shown in Fig. 3 gives surprisingly good results.

As shown in the figure, an ordinary transmitter or microphone button, after being placed inside of the phonograph tone arm, is connected to the usual microphone transformer, and thence to the amplifier.

The experimenter may wish to experiment with direct coupling, by wedging the microphone unit solidly against the tone arm, or with acoustic coupling by interposing sponge rubber between the edge of the button and the wall of the tone arm.

A HANDY TOOL

Maurice B. Knight

THE best kink I know of is a tool designed by the writer used in his shop. In Fig. 4 this instrument is illustrated.

It is made of a piece of brass rod, 12 ins. long and 1/4 in. in diameter. It is ground to the shape shown; hack saw a slot 1 in. deep at each end to obtain the required spring effect.

This little tool will not only enable screws to be placed in otherwise inaccessible positions, but also makes it convenient to start nuts in out-of-the-way places in order that the socket wrench may be brought into use.

VOLTAGE DOUBLING CIRCUIT

Joe Reilly

MANY, many times have I wanted to raise the voltage from my "B" unit, but just as many times have I failed. Finally, I hit upon the scheme shown in Fig. 5. Since hitting on the idea, I came across several similar schemes—which always happens to me—but thought the circuit may help another unfortunate brother.

As may be seen, dry rectifiers are used, and the condensers should have a capacity of about 4 mf. Other than this, the circuit is self explanatory. This is also the circuit of the device described in the May, 1932 issue of RADIO-CRAFT, page 656.

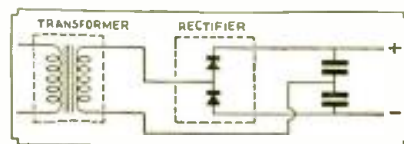

Fig. 5

Voltage Double Circuit.

\$5 for a Practical Radio Kink

As an incentive toward obtaining radio hints and experimental short-cuts, "Radio-Craft" will pay \$5.00 for the best one submitted each month. Checks will be mailed upon publication of the article.

The judges are the editors of "Radio-Craft" and their decisions are final. No unused manuscripts are returned.

Follow these simple rules: Write, or preferably type, on one side of the sheet, giving a clear description of the best radio "kink" you know of. Simple sketches in free-hand are satisfactory, as long as they explain the idea. You can send in as many kinks as you wish. Everyone is eligible for the prize except employees of "Radio-Craft" and their families.

This contest closes on the 15th of every month, by which time all the Kinks must be received for the next month.

Send all contributions to Editor, Kinks Department, c-o "Radio-Craft," 98 Park Place, New York City.

Radio's *Greatest*

The most
Complete Directory of Radio Circuit Diagrams—
in **ONE VOLUME** of over **2,300 Pages**
with **Extra Heavy Cover—Looseleaf Bound**

Buy this Big Volume on our *New*

DEFERRED PAYMENT PLAN

Here are two of the most surprising announcements that we have ever made to the radio trade and we know that it is such good news that every radio man will be greatly enthused.

FIRST—that the three editions of the OFFICIAL RADIO SERVICE MANUALS have now been combined into one big volume of over 2,300 pages.

SECOND—that this new single volume of consolidated radio circuit diagrams and complete radio servicing course can be bought on a deferred payment plan—and at a big saving for you.

It is needless to say how valuable the OFFICIAL RADIO SERVICE MANUALS have been to members in every branch of the Radio Industry, and how many thousands of each edition have been sold to manufacturers, jobbers, dealers, Service Men and experimenters. But we must emphasize this one fact: Service Men now realize that they are tremendously handicapped without the full set of Gernsback Manuals. So much so, that those who have purchased only one or two volumes, are NOW ORDERING THE MISSING BOOKS. They want their files to be complete.

The complete book gives you a volume of over 2,300 pages with over 5,500 diagrams, charts and photos. There are absolutely no pages or illustrations or diagrams duplicated.

There is no radio book published today which is so modern, up-to-the-minute, and which contains so much useful information as is to be found in this single volume. It is a book that will outlast any other radio book in print. Look carefully at the photograph of the complete edition on the opposite page. It measures 9" wide, 12" long, 4½" thick.

Included in this volume is a complete radio servicing course. This course covers every step needed to learn the servicing business . . . from starting in business . . . materials needed . . . and how to go about servicing receivers and repairing other radio equipment. This course in itself, is actually worth the price of the entire book.

Our new plan now enables every radio man to get this single volume—a Complete Directory of all Circuit Diagrams, of over 2,300 pages, on deferred payments. You can order this book immediately—get it in a few days, and use it while you are doing servicing work. You can make the first few calls pay for the entire cost of the book.

For you to get this book is quite simple and it is sent to you as soon as your order is received. You pay for it in small monthly amounts which can be taken from your earnings. If you were to buy the three volumes separately, the total cost would be \$17.00, including the supplements.

Now you can get the

1931 OFFICIAL RADIO SERVICE MANUAL, with Supplements,
1932 OFFICIAL RADIO SERVICE MANUAL, with Supplements,
and the 1933 OFFICIAL RADIO SERVICE MANUAL Complete

at a big saving.

THE SPECIAL NEW PRICE FOR ALL THREE MANUALS, WITH SUPPLEMENTS, IN ONE VOLUME, WITH HEAVY BINDER IS ONLY

\$14.00

You buy this book this way—

Send \$3.00 with order—

Pay \$5.00 to Express Company upon receipt of book.

Send \$3.00 thirty days after receipt of book.

Send \$3.00 sixty days after receipt of book.

Total \$14.00.

IF THE ENTIRE AMOUNT IS SENT WITH YOUR ORDER, WE WILL ALLOW YOU A 10% DISCOUNT. THIS CAN BE DEDUCTED FROM YOUR REMITTANCE.

IMMEDIATE SHIPMENT

Mail Coupon Today!

GERNSBACK PUBLICATIONS, Inc.,
96-98 Park Place, New York, N. Y.

Gentlemen:

In accordance with your Special Offer, I enclose herewith \$3.00 as first payment toward the One-Volume Radio Manual. Please forward it to me promptly. Upon receipt of the book, I shall pay express company \$5.00. Thirty days later I shall send you \$3.00, and sixty days after receipt of books, I shall send you my last payment of \$3.00.

If you want to take advantage of the Special Discount of 10%, remit only \$12.00 with this coupon.

Name _____

Address _____

City _____

State _____

RC-233

Over 2,300 Pages

Over 5,500 Illustrations

**THIS IS THE GREATEST SINGLE
VOLUME RADIO BOOK IN PRINT TODAY**

GERNSBACK PUBLICATIONS, Inc.

96-98 Park Place

New York, N. Y.

Servicing Book!

Over
2,300 pages
Over
5,500
illustrations

Consolidated
Official Radio
Service Manuals

Consolidated Official Radio Service Manuals

Complete Radio Servicing Guide

Up-to-date Directory
of all
Commercial Radio Receivers

RADIO-CRAFT'S INFORMATION BUREAU

SPECIAL NOTICE TO CORRESPONDENTS: Ask as many questions as you like, but please observe these rules:

Furnish sufficient information, and draw a careful diagram when needed, to explain your meaning; use only one side of the paper. List each question.

Those questions which are found to represent the greatest general interest will be published here, to the extent that space permits. At least five weeks must elapse between the receipt of a question

and the appearance of its answer here.

Replies, magazines, etc., cannot be sent C. O. D. Inquiries can be answered by mail only when accompanied by 25 cents (stamps) for each separate question.

Other inquiries should be marked "For Publication," to avoid misunderstanding.

SET SENSITIVITY—"MICROVOLTS-PER-METER"—CORRECTION

(183) Mr. Basil Farrakut, Chicopee Falls, Mass.

(Q.1.) What is the difference between a set with a sensitivity of perhaps 1. microvolt and another of 0.1-microvolt?

(A.1.) This question is perhaps most easily answered by considering two actual receivers of similar type but having different degrees of sensitivity. For this comparison we are using the automotive receivers of Galvin Mfg. Co. The model 61 superheterodyne receiver shown in RADIO CRAFT Data Sheet No. 75, October, 1932, has a sensitivity of 1. microvolt absolute (this is equivalent to 0.25-microvolt-per-meter); the model 88 superheterodyne receiver has a sensitivity of 0.1-microvolt absolute (or 0.025-microvolt-per-meter). The circuit of the latter instrument is shown in Fig. Q. 183 A.

In the type 61 receiver a power output of 2 watts is obtained with an input potential

of 10 microvolts; in the type 88 receiver a power output of 2.5 watts is obtained with an input potential of 4 microvolts.

A receiver of more simple design, the type 5T71 T. R. F. set, has a sensitivity of 5 microvolts absolute (1.25 microvolts-per-meter). With an input of 30 microvolts there is obtained a power output of 900 milliwatts. The schematic circuit is Fig. Q. 183 B.

Incidentally, the models 61 and 88 superheterodyne receivers have an I. F. of 175 kc., and the tuning condensers have a capacity of 367 mmf.; the oscillator plates are shaped.

(Q.2) What is the difference between the terms "microvolts" and "microvolts-per-meter"?

(A.2) The term microvolts is not used alone—the correct designation is "microvolts absolute" or "microvolts-per-meter." The term microvolts-per-meter is based on the use of a theoretically perfect antenna elevated four meters (13.12 ft.) above a theoretically perfect ground. Measurements made with such antenna conditions are indicated as

microvolts absolute; per meter above ground. A more convenient figure to use, would be one-quarter of this, or the number of microvolts-per-meter (thus, a good antenna 39.36 ft. (12 meters) above a good ground would have a pickup three times as great as the "standard," in terms of microvolts absolute, or 12 times as great in terms of microvolts-per-meter.

The sensitivity is determined by adjusting the microvolt output of a calibrated A. F. modulated R. F. oscillator connected to the input of the receiver until the audio output of the set as indicated on an A. F. output meter is the rated output of the power tubes. This sequence of operations is indicated in the block illustration, Fig. Q. 183C. The inductance L in the standard or "dummy" antenna may be made by winding 50 T. of No. 28 D. C. C. wire on a form 3/4-in. in diameter, which is designed to simulate the characteristics of our "theoretically perfect" antenna elevated four meters above ground.

(Continued on page 191)

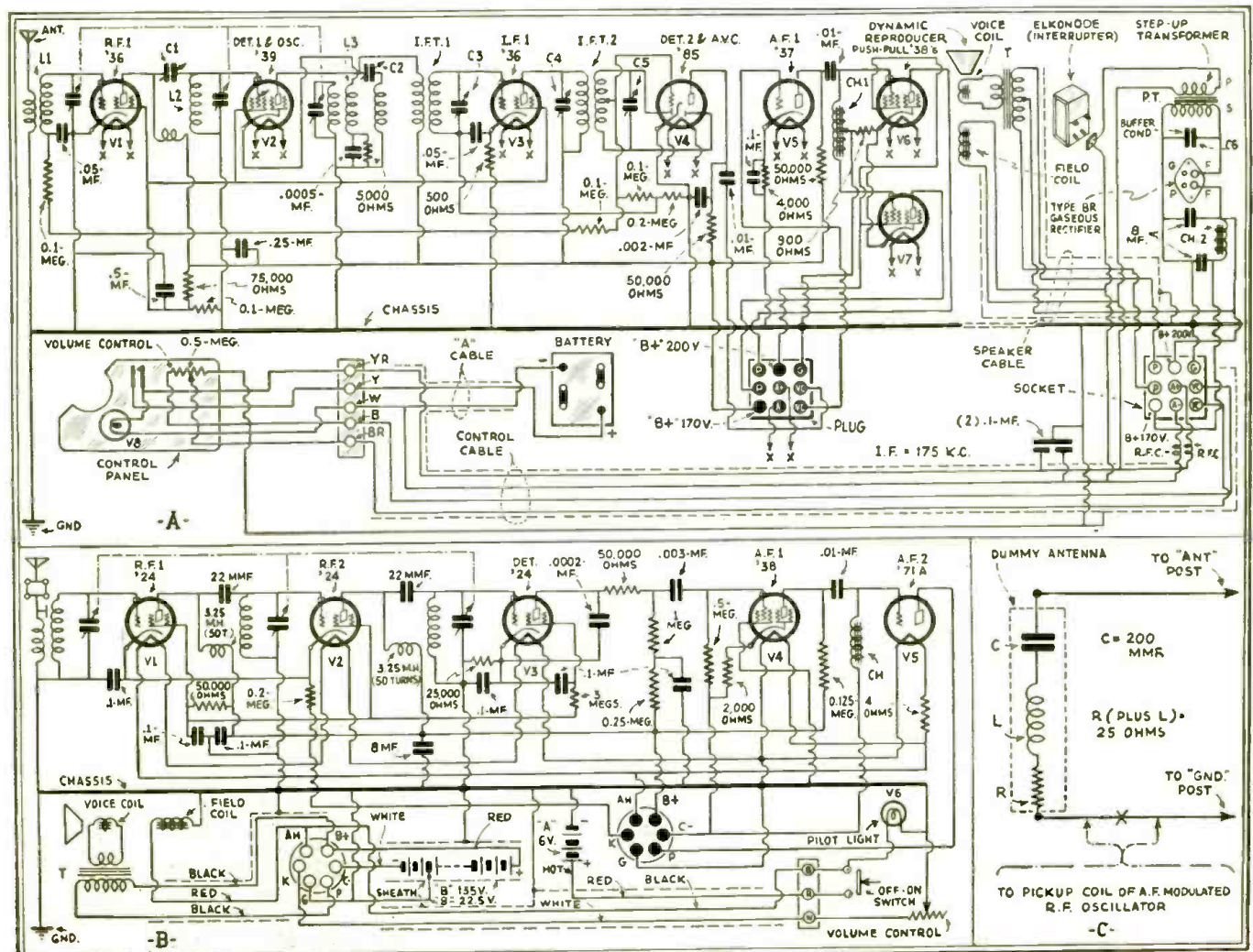

Fig. Q. 183. At A, the Galvin model 88 automotive receiver; condenser C1, 13.6 mmf.; C2, 500 mmf.; C3 to C5, 80 to 200 mf.; C6, .05-mf.; field coil, 4 ohms. At B, the model 5T71; tuning condensers, 410 mmf. At C, details for a "dummy" or substitute antenna for testing radio sets.

L. W. TUNER

(Continued from page 461)

—German, U.S.S.R., French and English stations on their long waves, above the American "broadcast" band—and quite another in its accomplishment.

The following factors were found in the equation: Overall sensitivity, selectivity, threshold sensitivity, zero-beat tuning, cross-talk, and output volume.

The first consideration is "overall sensitivity," or the "gain" of the tuner chassis. Anyone who has experimented with long-wave phone reception will verify the statement that extreme sensitivity is absolutely essential. Preliminary work indicated that a minimum of three screen-grid tubes would be required, plus a screen-grid detector. Resistor R1 controls the overall sensitivity of the set, while resistor R4 establishes a minimum bias which prevents the R.F. tubes becoming detectors at low input signal levels. Adequate bypassing prevents parasitic circuit oscillation.

Long-Wave Band Selector

It was then found that the set would be quite useless unless some means could be provided to eliminate static, code signals, and cross-talk due to adjacent-channel reception. Since "high-gain" R.F. transformers were required in connection with the screen-grid tubes, it was found that the four tuned input circuits were not quite sufficient, therefore, the circuit of L3, L4 was arranged as a band-selector.

To overcome the loss occasioned by the use of this band-selector, and to maintain high threshold sensitivity at the detector, a regenerative circuit was used for V4. For continuous-wave code reception, and to furnish zero-beat tuning as a convenient means of locating the phone stations, this circuit is permitted to oscillate.

The high degree of selectivity obtained through the use of four tuned stages and a band-selector, plus a regenerative detector, makes it cut side-bands. However, side-band cutting and regeneration are desirable factors, since fidelity is of less importance than DX (long distance) reception.

To still further enhance the threshold sensitivity of the detector, a grid-leak-and-condenser circuit is used. The grid leak, R3, is one of the panel controls. The sensitivity and, to a certain extent, selectivity (as determined by the degree of regeneration), and the reception of C.W. code signals and broadcast station carriers (by "spilling over" or oscillating the detector circuit), are under the control of R2, which varies the screen-grid voltage of V4.

To prevent high input signal levels causing the control-grids of the R.F. amplifiers to go positive, type '35 tubes were selected, because of their variable-mu characteristic, as V1, V2, V3. This prevents "cross-talk" or adjacent-channel interference due to the R.F. amplifier tubes becoming detectors.

The output volume is dependent upon the circuit arrangement following V4, and is entirely a matter of individual preference. In the writer's design, for instance, the detector is connected to a type '24 first A.F. amplifier (through the operation of a master change-over switch which connects the assembly as a short-wave, broadcast, or long-wave receiver), and the '24 is coupled to a single '47. Resistors R5 and R6 (in the separate A. F. amplifier) are adjusted for best results and then left at this setting. Another experimental expedient, to secure better ganging, was the use of a panel-operated variable condenser as C1A, in lieu of the unit supplied with the condenser gang.

Coil Construction

The long-wave transformers were made as follows: Each secondary (except that of L3) is made by winding 180 T. No. 36 enam. wire, leaving a space of 1/8-in., and

(Continued on page 491)

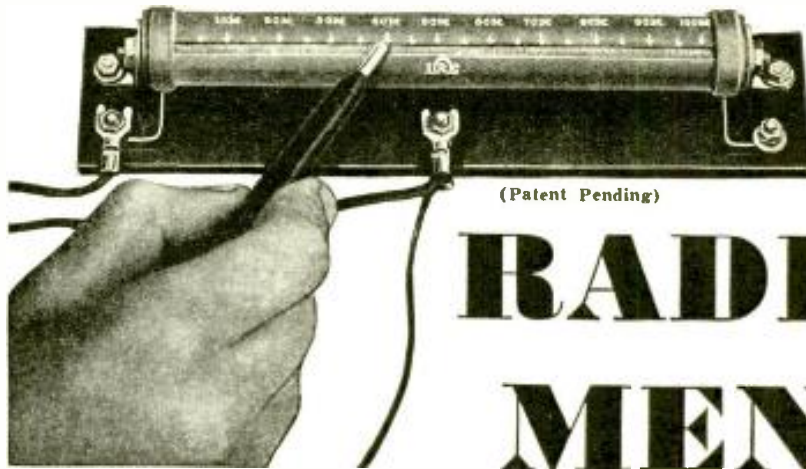

Get This New

IRC RESISTOR INDICATOR

An ingenious device which tells INSTANTLY the replacement value of any burned out or damaged resistor.

Small, compact, neatly boxed—slips into your vest pocket. Devised by I. R. C. engineers to be your constant companion on every repair job. Complete information on operation goes with it.

List price \$4. Sold for \$2.40 NET to Dealers and Servicemen (Higher in Canada)

FREE with the

NEW I. R. C. COMBINATION KIT No. 6

This most valuable of all Kits, is a permanent steel cabinet for your service bench. Contains 1/2 Watt, 1 Watt and 2 Watt Metallized Resistors and 5 Watt and 10 Watt Power Wire Wound Units—all in the most popular ranges used in all makes of radio sets. Has compartments also for screws, nuts, bolts and various service tools. An orderly method of keeping resistors and equipment. Stock card in lid acts as quick reminder for replenishing stock. Once you see this Kit, you'll give it a hearty welcome and a permanent home on your bench.

List price of Kit \$30. Sold for \$16.50 net to Dealers and Servicemen (Higher in Canada) with free sales helps listed in coupon.

Contains *Metallized* and Power Wire Wound Resistors

Ask your Jobber or write us direct

International Resistance Co.
Philadelphia, Pa. and Toronto, Ont.

International Resistance Co.
2006 Chestnut St., Philadelphia.

- () I enclose (check) (money order) for \$16.50. Please see that I receive your Combination Kit, also your Resistor Indicator, Resistor Guide and Color Code Chart.
- () I enclose (check) (money order) for \$2.40. Please forward your Resistor Indicator.
- () Please send catalog and complete data on your Service Helps.

Name _____

Address _____

City _____

State _____



AERO

INTERNATIONAL

ALL WAVE 11-TUBE

SUPERHETERODYNE DE LUXE



Completely Assembled
With 2 Matched Full
Dynamic Speakers **\$29.75**

At last! World wide reception at a sane price. 15 to 550 meters. Besides the regular broadcast band, it brings in foreign programs, amateurs, police calls, ships at sea and aeroplanes. One dial control. No plug in coils. Latest super-phonie tubes.

AERO 4-TUBE MIDGET

\$10.95 less tubes
2.95 kit of tubes



The lowest priced quality Midget Receiver on the market today. Very selective, brings in long distance like local stations.

AERO 5-TUBE MIDGET \$11.90
AERO 6-TUBE MIDGET .. 18.50

AERO WORLD WIDE



1-Tube SHORT WAVE
SET for Head-
phone Operation
\$5.95

Listen in DIRECT to London, Paris, Berlin, Buenos Aires and other broadcasting stations throughout the world via short waves. Your ordinary receiver cannot tune in these low wave stations. WORLD-WIDE RECEIVER, Aero 2-Tube Short Wave Set \$8.75. The same as above set but it has 1 stage of Audio Frequency added to it.

Write for Complete Catalogue.

CHARLES HOODWIN CO.

4240 Lincoln Ave., Dept. B-150 Chicago

TOBE

100
VALUABLE PRIZES
For
SERVICE MEN
DEALERS
EXPERIMENTERS
AMATEURS

1st Prize **\$485.00**
TOBE Interference
Locator and Signal
Strength Meter

2nd and 3d Prizes **\$365.00**
TOBE Noise
Locators

97 OTHER WONDER-
FUL PRIZES GIVEN
AWAY FREE
IN THE TOBE CONDENSER
CONTEST.

Get your entry blank today at your jobber
or write direct to the Contest Editor.

TOBE DEUTSCHMANN CORP.
Canton, Mass.

INTERESTING LOUDSPEAKER FACTS

(Continued from page 467)

due to them. Thus, the entire theory of having two differently peaked speakers is broken down, for if there are no sharp peaks to be compensated for, then there surely is no need of deliberately putting these peaks into the design of the reproducers.

If, now, these two excellent, well-designed speakers are connected across the amplifier output, then the question of doubling the high frequency distortion looms up at once. The ideal solution to the problem would be to use a third speaker especially designed for the higher frequencies. Then, by shunting both original speakers with low-pass filters, and by using a simple high-pass filter on the high-frequency speaker, each will reproduce only three frequencies that are passed by the filters. At the same time, advantage is taken of the low-frequency gain (as shown by Wolff), but with the elimination of the frequency distortion in the higher frequencies. This is shown in Fig. 4A.

If the use of a third speaker is not desired, then one of the two original speakers should have a low-frequency filter across it, so designed as to cut off sharply at about 800 cycles, which is the optimum value of the low-frequency gain through this arrangement (Fig. 4B). If this is done, then only one speaker will operate on the higher frequencies, with the result that high-frequency distortion could be no greater than that obtained with a single speaker.

Many manufacturers have claimed that the frequencies above 5,000 cycles are valueless, and only give the listener the impression of considerable background noise. However, it is an actuality that certain musical instruments, voices and many common sounds such as handclapping, or the jingling of keys or coin have harmonics or overtones which make a system of good reproduction have a decided lack of brilliance, if frequencies above 5,000 cycles are eliminated.

In conjunction with this, is the fact that the present engineering trend is toward the repro-

duction of the higher frequencies, and this is evidenced by the work of the Bell Tel. Labs., whose work with new type phonograph recordings has already been mentioned. Now, so far as the broadcaster is concerned, it is an established fact that the average broadcaster is satisfied if his station is transmitting up to 5,000 cycles. There is nothing in the Federal Laws that prohibits the broadcaster from transmitting more than 5,000 cycles, if he can do it. Broadcasters are separated by a 10 kc. band width; but this separation applies to the carrier frequency, and if it were possible to transmit up to, say, 7,500 cycles, the listener would find it advantageous to have a receiver capable of reproducing these higher frequencies, as there is a realism that is entirely lacking when these frequencies are absent. Unfortunately, our wire telephone network lines have difficulty in transmitting over about 6,000 cycles; but when we consider the average radio receiver, we find that there are very few that even reproduce as high as 4,000 cycles!

Thus, it becomes at once evident, that possibly the best arrangement of speakers for the home receiver is one in which these higher frequencies can be reproduced. Though some may consider the tone control a contaminator of good music, nevertheless if such a high frequency system were incorporated it would also be good policy to have a tone control that would cut down to about 4,000 cycles as there are many people who do not appreciate true reproduction, but like only to listen to the lower frequencies.

The high-frequency speaker should start working at about 2,000 cycles, and go to the highest frequency desired without breaking up. The speaker that is used by the Bell Lab. is shown in Fig. 1. Personally, I believe that a good dynamic unit with a small molded cone will prove more satisfactory than the Bell Labs. speaker, but, of course, this remains to be proved.

SLEUTHING FOR STATIC

(Continued from page 469)

per-meter. This whole amplifier, which covers a spectrum from 530 to 1,590 kc., is so designed and shielded that if the six-foot telescopic rod antenna is removed, the instrument may be placed in a location where the field strength is as great as 10,000 microvolts-per-meter without giving an appreciable indication on the meter!

The Schematic Circuit

The diagram of the "232" receiver is published for the first time (without the signal-generator portion of the circuit) in Fig. 1. It will be noted that a resistance-coupled A. F. system is employed, with a type '30 tube in the last stage feeding into an output transformer, T. As the instrument is designed to be as light as possible, it was not found feasible to even use the type '31 power tube in the last stage, as this would draw considerably more power from the small "A" and "B" batteries.

The output meter recording the intensity of the signals is critically damped to a half-second period. Considerable experimenting has shown that if an undamped meter is employed, the pulse type of interference, such as emitted by various devices, would give a greater indication on the meter than corona, etc., whereas, the latter is more disturbing to a broadcast program. Also, if the meter has too short a period, ordinary interference or broadcast signals will be extremely difficult to read, as the indication of the meter will follow the intensity of the signal too closely rather than indicate somewhat average values. Thus the meter employed is designed to give a fairly accurate value of the intensities of all types of interference as to their effect in disturbing broadcast programs.

A signal generator is incorporated in the same case with the receiver so that the intensity or noise range of any signal may be measured in terms of microvolts-per-meter. Adding this generator presents a number of problems. First, the generator must be totally shielded so that its signals enter the receiver only through the calibrated attenuator, which varies the input from 0.5-microvolt-per-meter to 50,000 microvolts-per-meter. Then,

too, its output waveform should be designed to simulate "noise" (interference) rather than a pure note; also, like normal static (interference), the signal should blanket the entire broadcast band of 550 to 1,500 kc. with an intensity depending upon the setting of the calibrated attenuator.

In this design a multi-vibrator system is used and set to give out approximately a 120-cycle note; its harmonics extend to all frequencies in the broadcast spectrum. Although the intensity of the harmonics diminishes as the frequency increases, which would mean that the input of the set would change quite radically with the frequency at which the receiver may be tuned, with the present design these characteristics can be smoothed out by filter circuits.

The instrument measures only 8 x 12 1/2 x 14 ins.; with batteries, antenna and all equipment, including the headphones, the weight is slightly less than 31 lbs.

Operating Procedure

Now let us travel around a bit with the Service Man and find out just what is his procedure in shooting trouble. His first step, upon arriving at his destination, is to connect the home antenna to the interference locator, after having removed the collapsible rod antenna. Then he tunes in a broadcast station and sets the volume control so that the meter gives about full-scale reading. By the turn of a switch the signal generator is started and correctly connected to the interference meter; then, by turning a knob, the generated signal is brought to the same meter reading as that previously obtained for the broadcast signal. Interpreting the setting of the generator attenuator dial by means of a curve (calibrated for the individual interference meter) gives the intensity of the signal in microvolts. This process is repeated for the interference, and the ratio of signal-to-interference can be readily calculated.

If the complainant's set is of the A. C. type, it is necessary to connect the interference locator to the light-line through an adapter, to determine whether the interference is being

picked up "backward"; that is, via the light-line outlet, through the power pack, and thence into the tuner portion of the receiver chassis. Usually, the interference is picked up over the antenna, and a survey (with the locator) of the immediate surroundings will show whether a change in direction, or position, or both, of the complainant's antenna would help him. Figure C illustrates a test of this type. If the interference is sufficient to warrant locating its source, the trouble-shooter takes his car and makes a complete survey of the surrounding territory, taking intensity readings. Faults in power systems are located in the same manner, as shown in Fig. D. After some experience, it is quite easy to run down and determine the origin of interference.

The interference meter may also be used in determining field strengths of various stations at different times of the day. For instance, one evening WFAF (New York) had a field strength of 38 microvolts-per-meter, while in the daytime the figure had dropped to less than 3 microvolts-per-meter. In another instance KFI (Los Angeles) had a field strength of 2 microvolts-per-meter, and KNX (Hollywood) 1½ microvolts-per-meter, at Winchester, Mass., one morning at 2 a. m.

The writer feels that the type 232 interference locator has opened for progressive radio service stations a new field and source of income. A man equipped with one of these instruments and having a reasonable knowledge of the art will be capable of engaging in the work of making interference surveys for a good many cities and towns now desperately in need of such service.

Finally, the writer wishes to point out an entirely new and hitherto unheard summons by "Opportunity." Police radio stations are springing up throughout the country with a rapidity almost akin to the growth of mushrooms. Strange to relate, there is seldom any effort made to take field intensity measurements to determine the most suitable location for the transmitter, a procedure which in many instances would effect a saving of thousands of dollars and permit good reception in districts which otherwise would not be in the area of good service. *Bastante?*

L. W. TUNER

(Continued from page 489)

then winding another 180 T. (The winding length of each section is 1 in.)

The secondary of L3 has 175 T. per section. The secondary sections of L5 are separated only 1/64-in. All the secondaries are wound on a tube 1¼-in. in dia.

The primaries of all the coil units are wound over the filament end of the respective secondaries, No. 36 enam. wire being used. Primary and secondary are separated by one layer of Empire cloth. A tabulation of coil turns is given below:

Coil	Primary	Secondary
L1	40	360
L2	75	360
L3	75	350
L4	20	360
L5	75	360

The R.F. choke, R.F.C., is made by winding two two-section layers, one over the other, on a form 1¼-in. in dia., using No. 36 enam. wire. The first and second sections of each layer are spaced 3/16 in. After the first layer of 360 turns (180 turns in each section of each layer) is completed, three layers of Empire cloth are wound over the secondary and the second layer of 360 turns is wound; the starting lead of the second layer is cut back directly across the first layer (inside the tube), to a position directly over the starting lead of the first layer.

List of Parts

One Clarostat long-wave coil kit (see text), L1 to L5;

One special R.F. choke (see text), R.F.C.;

One Pilot 3-gang condenser (with trimmers), 350 mmf., C1 to C3;

One Pilot 2-gang condenser (with trimmers), 350 mmf., C4, C5;

One Pilot midget condenser, 50 mmf., C1A;

(Continued on page 496)

NEVER!
BEFORE!



15 DAYS'
FREE TRIAL

SQUIRE

announces

AMAZINGLY NEW 1933 RADIO RECEIVERS

Beautiful Cabinets—Not to be Compared
with any other line on the market

OUR PRICES BEAT ANY LINE SOLD COMPARABLE IN QUALITY

*We are the largest exclusive producers of midget
radios in the world.*

Model AC-25-795

5 TUBE
RADIO

USING

1-C56; 1-C57; 1-C58;
1-C47; and 1-C80

CUNNINGHAM
TUBES

FOR RURAL
COMMUNITIES

Model AC-35-916 us-
ing 2-C57; 1-C58;
1-C47 and 1-C80



PRICE
COMPLETE
WITH

5 CUNNINGHAM
TUBES

\$18.95

FOR RURAL COM-
MUNITIES

\$19.95

The Squire Radio Receiver is the last word in radio engineering design. Mr. Frank Squire has been in radio since 1908, beginning his career with A. H. Grebe & Company, he served the DeForest Company as chief engineer for six years, and has been responsible for the designs of most of the radio receivers now on the market. The chassis in the radio cabinet above is the result of his years of experience. All parts are mounted on steel. Such famous radio parts as Dutilier, Rola, Hammarlund, Cunningham, Centralab, Crowe, General Instrument, Cutler-Hammer, Aerovox and other prod-

ucts are used in the construction of our receivers. The cabinet is of beautiful oriental walnut, extremely graceful in design, with fluted legs and pilasters. It is sturdily constructed to last a lifetime. Height 29"; Width 17¼"; Depth 9¼". The receiver employs a Rola Dynamic speaker which as most radio people know is the finest speaker on the market. The set utilizes the new 56-57-58 series tubes. This set has a 4000 mile receiving range without noise or hum.

WRITE FOR CIRCULAR. WE MANUFACTURE 22 DIFFERENT MODEL RECEIVERS
AND CHASSES

DEALERS! Write for Exclusive Territory.

Licensed under patents granted
RADIO CORPORATION OF AMERICA—GENERAL ELECTRIC—WESTERN ELECTRIC—
AMERICAN TELEPHONE & TELEGRAPH COMPANY—WESTINGHOUSE ELEC. & MFG. CO.
AND THE HAZELTINE CORPORATION

RADIO CHASSIS, INC.

(Formerly Marquette Radio, Inc.)

112-116 West 18th Street

New York, N. Y.

Export Department: 1457 Broadway, New York, N. Y.

Attention Supreme Jewel Weston Owners!

Have your old Model Diagnostics or Analysers converted or remanufactured to this new and modern instrument just announced.



The many exclusive features of the new Model 400-C will amaze you—complete resistance analysis directly on the analyzer panel, all tubes, 4, 5, 6, 7, prong types WITHOUT adapters, tube tester, capacitor tester, shielded oscillator, etc. And the best part is that we save you real money by using the meters, resistors, etc., from your old instrument. Many combinations to choose from—many prices.

Send Today



SUPREME INSTRUMENTS CORPORATION
455 Supreme Bldg., Greenwood, Miss.

Please send me without obligation your new Model 400-C and include all data and prices of modernizing my Analyzer. Make _____ Model _____

Name _____

Address _____

City _____ State _____

A. C. METERLESS TUBE TESTER

(Continued from page 473)

audio transformer, AT. A variable-ratio A.F. transformer is used in this circuit because the pairs of terminals, chosen, work very nicely to give the best results for all makes of tubes; although any make of transformer may be used if a special chart is made. The use of the parts specified is advised, as it simplifies construction and obviates any extra work.

Inside the box we mount the filament transformer FT at the top, and the audio transformer AT at the bottom, as shown in Fig. B, making sure that no hum is induced into the latter by coupling. The correct placement may easily be determined by connecting phone tips to terminals G8 and F6 of AT and listening for hum as FT is turned on and AT is placed close to it. When the 60-cycle hum is heard, rotate AT 90 degrees and the hum will disappear. The "C" battery is held close to FT by a removable strip of wood to allow replacement at the rare intervals when necessary.

The wires running from the box to the panel may be tied into a cable with string to allow the panel to be mounted and removed without entangling alliances. Be sure to mark which throw of the toggle switches is which to avoid guesswork after the panel is mounted. The binding posts provided for the measurement of filament voltage, HH, and "C" battery voltage, CC, are convenient for checking voltages, though not necessary for actual operation. No great precautions are necessary to avoid coupling between leads in this circuit, except to twist the A.C. leads if they are too long.

In connecting the potentiometer be sure that the plus end of the "C" battery connects to the end of R3 marked 1, which is the last tap when R3 is rotated to the right, otherwise the readings will be reversed. The method of using a flexible lead from the screen terminal of the 6-prong socket was used because this lead remains connected to the P binding post for all tubes except in the one case when testing the triode section of the 55. This infrequent use does not warrant providing a switch.

Operation

Proceeding now with the operation of the tester, all switches are thrown to their normal position as shown in Fig. 2 and (N) on the chart. Locate the tube type number on the chart and set the switches and rheostat to the points given. Rotate the potentiometer dial, R3, from its 10 position toward the right until a note is heard in the phones. We take as our figure that number where the tube first starts oscillating (that is, the highest number). If, for example, the note is first heard at 8 (though naturally it will be heard at all numbers less than 8, in the case of a '27 tube) we consult the chart for the limits of a good tube, and since, in this case, 10 to 5 means it is satisfactory, the tube is rated "good."

In the case of heater tubes, try the R3 dial about three times to get the same point of initial oscillation, in order to be sure that the tube is neither heating up nor cooling off while it is being tested. For non-heater (filament type) tubes, with R3 dial at some low number, rotate R4 (center-tap dial) either way, until the 60-cycle hum is least noticeable. There will be no trouble in distinguishing the much higher pitch of the tube oscillation from the 60-cycle hum. With R4 set, use dial R3 to get the figure for the tube, as described before. If the tube does not oscillate, disconnect one phone tip and tap it to its binding post to provide excitation for the circuit. If nothing, or only a click, is heard, you may be sure that the tube is unsatisfactory. If a voltmeter is used to check the filament voltage, at the filament terminals of the socket (binding posts HH), it should read 1.5 volts, when a '27 tube is being tested.

Tube Rating Chart

A chart is given to interpret the reading of dial R3 in terms of the worth of the tube. It is based on results obtained from many tubes of each of the forty types listed. As explained before, it is not valid except with the same make of major apparatus listed at the end of the article.

To make an individual chart, obtain readings on the finished tester for tubes known to

be good, weak, or worthless, using the same R2 and switch settings as listed for tubes having the same filament voltage and socket connections. In setting the limits for each class according to these readings, the limits will naturally be more accurate as the number of readings that are obtained for tubes of any given type are increased. The chart is reliable for all the tubes listed and can be extended at will. Those positions of the switches which vary from the normal position, for each type of tube, are given, but it may be well to classify the switches as follows:

SW.1, On-off switch for "A" supply and for "C" battery to prevent drain through potentiometer, R3.

SW.2, switched off for 2-volt tubes, thus inserting the extra 10 ohm resistance.

SW.3, thrown to P for screen-grid tubes.

SW.4, thrown to P for pentodes.

SW.5, thrown to H1 for all tubes not taken care of by the L.O. winding.

(Note: 5 V. tubes are tested on the L.O. winding.)

F1, thrown to F for testing the triode part of the 55.

Gc, the grid cap, which naturally must be attached to the cap of the tube.

Optional Addition

It will be noted that the chart does not include the rectifying tubes, (such as, the '80, etc.). Rectifiers, however, can be tested. The additional circuit and test parts are shown in Figs. 3 and C. It was purposely not included in Fig. 2 because, in the writer's opinion, it is unnecessary and adds to the cost and complexity of the circuit. The most satisfactory test for a rectifier, the '80, for example, is to substitute a spare, good tube in the socket of the questionable '80 and note any change in the output of the set. Where, ordinarily, substitution of one tube at a time in a multi-tube set is a very doubtful method, we have a positive test in this case, since we can eliminate consideration of the other tubes in the set by first testing them on the tester. This confines the test by substitution to the '80 only, and removes the previous objection. By taking advantage of this fact, we can avoid the additional cost and the use of any high power.

Figure 3 is given, then, for those cases where the substitution test for rectifiers cannot be used. The scheme employed is to use the rectified output of the '80 tube, being tested, as plate voltage instead of the 7½ V. battery. This plate voltage will then determine the worth of the '80 when it is applied to the plate of a standard, '27 tube (a good tube, which now becomes one of the accessories of the tester) to cause an audible oscillation. Thus, in Fig. 3, a good '80 being tested will supply about 80 ma. through the 1,800-ohm resistor R5 and 50-ohm potentiometer R6 connected in series. The voltage developed across R6 (about 4 volts) is then used as plate voltage on the standard '27 tube in the tester socket, and will cause a note to be heard at 8, let us say, as the R6 dial is rotated. When a poor '80 is being tested, its output, being lower, will cause less voltage across R6 and we will have to turn the R6 dial to a lower number (e. g. 2) to find enough positive voltage to start the oscillation. By consulting the rectifier chart, we then interpret the higher dial reading in terms of greater output and therefore greater worth of the '80 tube (or the '82 or '83) being tested. The '27 tube was arbitrarily chosen as the standard because of the ease with which it oscillates.

In practice, then, after the '27 tube is inserted and is oscillating in its regular testing circuit, connect the rectifier unit to the tester, Fig. 2. The phone tip PhA is removed and inserted in pin-jack PhB, (as shown by the dotted lines) thus connecting R6 in place of R3. With the rectifier turned on, and SW.7 thrown to 5 volts for the '80 tube, rotate dial R6 until a note is first heard in the phones. The chart is then consulted for this reading as before, giving the worth of the '80.

In constructing this unit, the usual care must be taken with the insulation of the high voltage leads. Since R5 becomes warm with

(Continued on page 507)

OPERATING NOTES

(Continued from page 479)

the upper amplifier, of a well-known installation. This equipment is of the rack and panel type, and contains two main amplifiers of three stages, double push-pull each. There are the necessary multi-contact switches to switch in reproduction from two sound heads, or from two pickups located near the projectors. Another multi-contact, double-throw switch selects the input of the amplifier to be used at the running; still another double-throw switch connects the output of either amplifier in use to the dynamic speakers behind the screen. At the upper end of the panel are two milliammeters with switch-board cords and plugs to read the plate current of the tubes in either of the main amplifiers, the plate current of the tubes in the head amplifiers on the wall, and also the voltage of the "B" batteries.

When the upper main amplifier was switched on for use, reproduction was very weak, but full volume could be restored by snapping the field switch of the monitor speaker off and then on. Sometimes there was difficulty in maintaining the correct volume level during the program.

The first thing that the writer did was to measure the operating voltages during the fading; these were found to be correct. Then new tubes of known quality were tried. Still the trouble remained. The writer, working on the theory that a faulty connection somewhere was causing the trouble, tried rocking the tubes around in their sockets, but there was no increase in volume. This eliminated the possibility of bad tube contacts causing the trouble. Since reproduction from the head amplifiers passed through two selector switches associated with that amplifier there was a chance that dirt on the contacts was causing the trouble. The writer burnished these contacts with a relay contact burnisher, and made cardboard tubes to fit over the switches, keeping out dust in the future. However, this did not remedy the trouble. Fully realizing that there could be a badly soldered connection somewhere, he resoldered every wire and connection with a hot iron, and was confident that this would put an end to the trouble, but he was badly disappointed.

After a serious study of the circuits, and some theorizing, the writer decided to concentrate on the audio transformers, which are a combination of resistance, condenser, and choke coupling, which accounts for a good fidelity of reproduction in this amplifier. Believing that leakage, or intermittent open circuiting of the coupling condensers might cause this trouble of fading, the writer tested those in each transformer at a higher voltage than normal. Each condenser had a small leakage of around thirteen megohms. This seemed to be normal, as all of them were the same. Since the condensers in each transformer unit were tested, the shell was rapped smartly with a screw driver to locate possible open circuits within. However, these tests showed nothing. The writer, despite all tests and the possibility of trouble in some other unit, still had a hunch that the trouble was in these audios, and he had to try the last resort to prove it.

Since there are two amplifiers exactly alike in the installation, one being the auxiliary, or alternate, the writer decided that the only way to find the trouble was to exchange parts from the amplifier affected to the spare. One by one the audios were transferred between the two amplifiers, until the writer was elated to observe that the second amplifier had the fading trouble. In this manner the trouble was definitely centered on one of the audios. Up to this time, just what the trouble is with this transformer has not been definitely determined, as it tests O.K. in every respect. The writer does not believe that heating and intermittent opening of the transformer primary circuit is the cause of the trouble, since the trouble was in existence when the amplifier was first turned on, and, therefore, the transformers were cold.

The writer was working on a certain radio which had low volume. All ordinary procedures were tried without good results, and the writer spent much time on it. A connection to connection test with a low reading ohmmeter, looking for bad connections, revealed nothing. Pressure on the condenser gang assembly which was a separate unit bolted to the chassis, caused the volume to be suddenly restored. Tightening up these bolts remedied the trouble.

Majestic 52

A customer brought the writer a new Majestic model 52 superhet, which would cut in and out of operation at frequent intervals. The Service Man for the company, who sold it, worked on it for a time, but was unable to find the trouble. He returned the set, blamed the trouble on a bad tube, and made a service charge. Meanwhile the radio was merrily cutting in and out in a most perplexing manner. The tube socket voltages, and unit values, were normal at all times. The writer discovered that by putting a certain amount of pressure on the rear end of the chassis near the right side, he could cause the radio to cut in and out at will, just as it did in operation. The chassis was turned over to expose the wiring and units underneath. Probing among the tube contacts brought no results, but it was discovered that pulling on the condenser shown as C-20 in the service data on page 162 of the February, 1931 issue of this magazine would cause the trouble. This condenser is a .01-mf. unit.

Westinghouse WR5

The writer was sent to a home by a dealer to locate a roaring noise in a Westinghouse WR5 superhet. No noise was apparent at the time, so tube socket voltages were read, and each tube was tapped to locate possible loose elements within. The screen-grid caps were cleaned, also the prongs, and the aerial and ground. The writer attributing the trouble to some local interference lasting temporarily, departed, but made several calls later to ascertain the customer's satisfaction.

Several weeks later the customer reported the noise bothering again. The radio was brought in for a going over, but operated well for several hours. Following a definite plan, the writer discovered that tipping the radio a little to one side would cause a short, popping noise, similar to unringing of a loose connection. Rapping smartly with a screwdriver handle on the radio-frequency chassis which is separate from the audio-frequency and power pack chassis, produced nothing. However rapping on the audio-frequency chassis resulted in a popping noise being reproduced in the speaker, a sure sign that there was a loose connection within this chassis. Turning this over so as to expose the wiring with the set still playing, and pulling on the primary wires of the power transformer, caused this same popping noise in the speaker. This of course centered the trouble in the power transformer.

Another Westinghouse superhet had a perplexing popping noise only at resonance, so much like interference that the writer was misled for a few moments. The fact that the interference appeared only at resonance point was very peculiar, and unusual. The writer had a happy thought and adjusted the voice coil of the dynamic speaker, which remedied the trouble. This is the first time that the writer ever heard speaker rattle, resemble interference so closely.

Considering these troubles the writer has come to the conclusion that when a good set analyzer will not disclose the trouble, then the only thing to do is to rap smartly, shake, and pull on every unit and wire in the entire chassis. The idea is to try and duplicate the trouble, if possible, by working on each part as just mentioned. When a unit is found that causes this trouble when disturbed by the hand, then it is likely that it is causing the trouble during the operation of the set.

NEW RADIO SCHOOL

In these times of depression, many Service Men are turning to allied fields to help fill their deflated pocketbooks. One of these allied fields is refrigeration.

Having founded the Philadelphia School of Wireless Telegraphy in 1912, Mr. J. C. Van Horn announces that he will open a new school for instruction in radio and refrigeration in Philadelphia, his home town.

A feature of this school will be the inclusion of special refrigeration servicing courses for radio men.

All radio men, or men interested in learning radio, should communicate with this school. Write to RADIO-CRAFT, 98 Park Place, New York, attention of The New Radio School.

about
\$1
per week

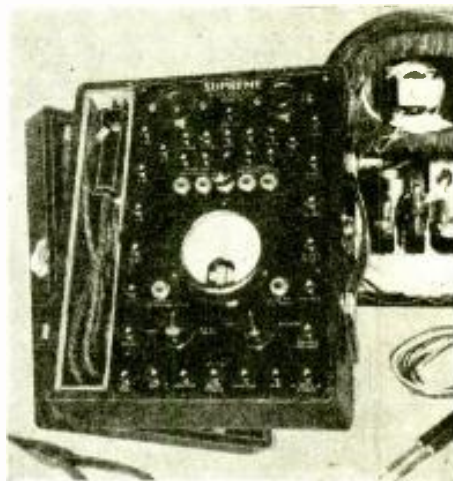

- new business - pays for this "SUPREME" ANALYZER

Will you spend about \$1 per week in 1933 to make several times that much more, every week, indefinitely? To modernize your testing equipment? That's how little the "Supreme" Analyzer averages you. Giving you the ease, speed and positiveness of the remarkable Supreme Multi-meter that insures faster, more profitable radio servicing. And it takes only \$1 a week new business to pay for this modern testing equipment.

SUPREME \$56.25
SET ANALYZER
MODEL 56

Dealers net price f. o. b. Greenwood, Miss.

Produced by the creators of the Supreme Diagonometer, "the complete portable radio testing laboratory."



Ask your jobber to demonstrate, and send the coupon for the free catalog that gives all the details of this incredibly flexible, popular priced Analyzer, also the Diagonometer, myriad other Supreme Instruments, Kits, and attractively priced parts and replacements.

SUPREME INSTRUMENTS CORPORATION.

452 Supreme Bldg., Greenwood, Miss.

Please send me the new Supreme 1933 Catalog which includes data on the Supreme Set Analyzer Model 56.

Name

Address

City

State

2 GREAT BOOKS
THAT WILL BRING YOU MORE MONEY

RADIO PHYSICS COURSE
\$3.50 Postpaid in U.S.
By A. A. Ghirardi

Here is the famous Radio Physics course in 15 lessons—running in Radio Review! The newest text book published in radio course everywhere! Explains the entire field of radio!

RADIO SERVICING COURSE
\$1.50 Postpaid in U.S.
By B. M. Freed and A. A. Ghirardi

Practical! You will be able to find out the trouble in any radio. Contains 182 pages, over 100 illustrations.

MAIL THIS COUPON AT ONCE!

RADIO TECH. PUB. CO., Dept. R.C. 2
80 Fifth Avenue, New York City

Enclosed find check, cash or money order for..... copies of Radio Physics Course at \$3.50 each, and..... copies of the Radio Servicing Course at \$1.50 each. Check here for FREE circular describing the contents of each book in detail.....

NAME.....
ADDRESS.....
CITY..... STATE.....

I. C. A. VARIO-DAPTER TESTS 54 TYPES OF TUBES!

No need to junk expensive equipment now that you can have this marvelous unit. Provides for all type tubes—present and FUTURE! Checks 5, 6 and 7 prong types including 29, 33, 34, 39, 41, 42, 43, 44, 46, 47, 51, 55 (diode) 56, 57, 58, 64, 65, 67, 69, (both plates of 80, 82, 83) 85, 89, Wunderlich, 91 (triple-twin) 93, 95. Your jobber can supply you or order direct from us using the coupon. Instruction sheet with each unit. Dealers Discount 40% off.

\$5.00

Insulinc Corp of America, Inc.
23-25 Park Place, N. Y. C.

Enclosed find check—money order for \$3.00. Send me a VARIO DAPTER, postpaid.

NAME.....
Street.....
CITY..... STATE.....

BETTER CONDENSERS AT LOWER PRICES

DUBILIER CONDENSERS

Yes, and we can prove it! Never was such quality offered in condensers. Never such low prices. Because never were such engineering efforts, new materials, novel production methods and rigid inspection placed behind such products. Dubilier—world's largest and oldest condenser specialist—offers you electrolytics, paper, mica, receiving, transmitting, industrial, laboratory and other condensers for the most reliable, longest and most economical service.

free CATALOG is yours for the asking. Just issued. Covers entire line. Write for your copy today.

DUBILIER CONDENSER CORPORATION
4377 Bronx Blvd., New York

INFORMATION

(Continued from page 488)

(Q.3.) In building Mr. Cisin's receiver which appeared in the October issue of RADIO-CRAFT, page 212, entitled "A Modern '3-Tube' Reflex Receiver," I cannot secure satisfactory results. Is there any data you may have available that may assist me, and that was not published in the article?

(A.3.) Yes. Inadvertently, we printed the size of resistor 14 as 500 ohms, 1/4 watt. It should be 5,000 ohms, 1/2 watt. Hope this helps you, old man.

CLASS A, B AND C AUDIO AMPLIFIERS

(184) Mr. Walter Schumann, Hoboken, N. J. (Q.1.) The terms "class A," "class B," and "class C," used in connection with audio amplifiers do not mean a thing to me. Please explain just what is the meaning of these terms in amplifier classification.

(A.1.) The following material, reprinted from the YEAR BOOK OF THE INSTITUTE OF RADIO ENGINEERS, completely answers this question.

Class A

In a class A amplifier the plate output waveform has essentially the same shape as that of the exciting grid voltage.

"This is accomplished by operating with a negative grid bias such that some plate current flows at all times, and by applying such an alternating voltage to the grid that the dynamic operating characteristics are essentially linear. The grid must usually not go positive on excitation peaks and the plate current must not fall low enough at its minimum to cause distortion due to curvature of the characteristic. The amount of second-harmonic present in the output wave which was not present in the input wave is generally taken as a measure of distortion, the usual limit being 5%.

"The characteristics of a class A amplifier are low efficiency and output with a large ratio of power amplification."

Class B

In a class B amplifier the power output is proportional to the square of the grid excitation voltage.

"This is accomplished by operating with a negative bias such that the plate current is reduced to a relatively low value with no grid excitation voltage, and by applying excitation such that pulses of plate current are produced on the positive half-cycle of the grid voltage variations. The grid may usually go positive on excitation peaks, the harmonics being removed from the output by suitable means.

"The characteristics of a class B amplifier are medium efficiency and output with a relatively low ratio of power amplification."

Class C

In a class C amplifier the output varies as the square of the plate voltage within limits.

"This is accomplished by operating with a negative grid bias more than sufficient to reduce the plate current to zero with no excitation. An alternating grid excitation voltage is applied such that large amplitudes of plate currents are passed during a fraction of the positive half-cycle of the grid excitation voltage variation. The grid voltage usually swings sufficiently positive to allow saturation plate current to flow through the tube. Thus the plate output waves are not free from harmonics, and suitable means are usually provided to remove harmonics from the output.

"The characteristics of a class C amplifier are high plate circuit efficiency and output with a relatively low ratio of power amplification."

NEW SERVICE CO.'S

● Since the original breakdown of Silver-Marshall, Inc., three separate companies have been formed, all composed of members of the original firm. Their chief engineer, Mr. Clough, has consolidated with Mr. Brengle to form the Clough-Brengle Co., manufacturers of service equipment. Mr. Silver has formed McMurdo-Silver, Inc.; and some of the original executives have retained the original name of Silver Marshall, Inc. This latter firm will continue with the original Silver-Marshall line of radio receivers.

NEW ADAPTER AND ANALYZER EQUIPMENT



SPECIAL 40 IN 1 ADAPTER

Here's what you have been looking for—nothing like it—highgrade tube checking adapter—tests over 40 tubes. No leads—no jacks or plug—no complicated directions. Resistances and toggle switch for instant reading of both plates of dual plate tubes—beautifully and ruggedly made—a typical NA-ALD product. List \$6.00. Servicemen's postpaid price \$3.75. Orders filled in sequence received. Do not delay—send order today. Tubes it will check in practically any checker are 19, 29, 33, 36, 37, 38, 39, 41, 42, 44, 46, 47, 49, 52, 55, 57, 58, 59, 64, 65, 67, 68, 69, 70, 80, 82, 83, 85, 88, 89, 93, 95, 985, 986, G-2, G-4, LA, PA, PZ, PZH, Wunderlich A and B. No. 950XYL, Servicemen's price \$3.75 postpaid.

NEW 7-Prong Analyzer Plug

907WL Na-Ald 7-Prong latch-lock analyzer plug. List Price..... \$3.50

907WLC Above plug with five feet of EIGHT wire cable. Eighth wire insures adaptability to possible future developments. List Price..... \$5.50

This new plug has a seven prong base which is reduced to a 6, 5 or 4 prong base by locking on the following adapters:

976DS 7-hole to 6-prong adapter with locking stud. List Price..... \$1.25

975DS 7-hole to 5-prong adapter with locking stud. List Price..... \$1.25

974DS 7-hole to 4-prong adapter with locking stud. List Price..... \$1.25

Replace the present UX socket of analyzer with the 456 or 456E composite socket which takes 4, 5 and 6 prong tubes and the present UY socket with the 437 or 437E seven hole socket.

456—50c, 456E—60c,
437—35c, 437E—40c

Directions for modernizing any Set Analyzer with the 7 prong Analyzer Plug, Assorted Adapters, Composite and 7-hole Sockets are furnished with orders for same.

976GL takes seven prong tubes in the 6 hole analyzer socket. The lead (not shown) is inserted into the control-grid pin-jack. List Price..... \$1.25

967SCL adapts the 6-prong Latch Lock Analyzer Plug for use in 7-hole sockets. Clip is connected to control grid and on plug. List Price..... \$1.50

Above two adapters used with Weston 660 and other set analyzers.

965DW enables any analyzer which can test '24 tube circuits to test all the new 6 prong tube circuits.

975DW enables any analyzer testing '24 circuits to analyze the new 7 prong circuits. List Price..... \$2.50 each

Set of four precision wound short-wave coils—20 to 200 meters with .0014 mfd. condenser. 7045WS List Price \$2.00 set
Set of two coils to cover 100 to 540 meters with .0014 mfd. condenser. 7045SW and 704SW List Price..... \$1.50

Send 10c for 26-page NA-ALD Adapter data sheets showing 300 diagrams, tube connections, etc.

Servicemen's Discount..... 35%
On orders amounting to \$10.00 List..... 40%

NA-ALD ALDEN PRODUCTS CO.
Dept. R. 715 Center St.
BROCKTON, MASS.

BUILDING THE SUPREME "56"

(Continued from page 471)

ranges up to 500,000 ohms when used with the self-contained 1.5-volt flashlight battery. A low range, 0-5,000 ohms, is provided so that resistor values as low as 2.5 ohms can be directly indicated. The basic sensitivity is also calibrated for three high-resistance, 2,750-ohms-per-volt, D.C. voltmeter ranges of 0-3.2, 0-32 and 0-320 volts. For A.C. and D.C. potential measurements at 1,000-ohms per-volt in six ranges, i. e., 0-3, 0-9, 0-30, 0-90, 0-300, and 0-900 volts, the meter is utilized with the rectifier and compensating resistors shunted to a full-scale sensitivity of 1.0 milliampere. The shunt is divided for providing five current ranges, i. e., 0-3, 0-9, 0-30, 0-90, and 0-300 milliamperes, A.C. or D.C. Any range of the meter can be used for any analytical test of radio circuits.

The six potential measuring ranges of the meter may be used for radio output measurements. A self-contained 0.5-mf. capacitor is included in the output measuring circuit so as to eliminate the D.C. component when the output measurements are taken directly from the plates of output tubes through output adapters. The complete instructions supplied with the analyzer include a capacitor chart which outlines the simple procedure to be followed for accurately measuring the capacitive values of paper bypass and filter capacitors from 0.002 to 6.0 microfarads.

The Model 56 includes a 10½ in. x 6½ in. bakelite finish panel drilled, and marked by the Veri-Chrome process. A list of all parts is included at the end of this article for the benefit of those concerned. A pictorial diagram, Fig. 1, shows the relative position of every part to be used in building the unit. The first step, then, is to become acquainted with the pictorial diagram. Locate the pin-jacks, jack-switches, etc., by reference to Fig. 1. Be sure to follow this pictorial diagram in the procedure of building the analyzer, since it shows the correct relation among the different parts used, whereas the point-to-point diagram (Fig. 2) represents merely the electrical circuit from point to point, and does not necessarily show the actual mechanical relation between the parts. Consequently, it should only be used for continuity tests, for repair purposes, as well as for checking the values of resistors, capacitors, etc.

Building Procedure, I

(a) Turn the panel over so that its back faces the builder.

(b) Insert all pin-jacks, J, in pin-jack holes, and tighten on panel with accompanying nuts.

(c) Insert 4-, 5-, and 6-hole universal tube socket in the socket-hole located in the upper right corner of panel, V2. Hold it to the panel with accompanying screws and nuts.

(d) Insert the 7-hole socket in the other hole and proceed as in (c), V1.

(e) Insert the six close-circuit jack switches, JS, in the following manner: 5 in the five jack-switch holes directly above the meter hole, and 1 in the jack switch hole marked "OPEN FOR AC METER." (Fig. 2.)

(f) Insert the one open-circuit jack switch JS, on the jack switch hole marked "CLOSE FOR 0-5,000 OHMS."

(g) Insert the 0 to 5,000-ohm rheostat, R1, in the ZERO OHMS ADJUSTER hole. Hold it to the panel with the nut.

(h) Insert the 3-position rotary switch SW.1 in the OHMS-HI. RES. V.M.—A.C.—D.C. METER hole in such a way that the middle position falls on the top. This can easily be ascertained by inserting the control knob on the switch shaft and locating the middle position by simply turning it.

Building Procedure, II

(a) Make all "socket-to-socket" connections following the pictorial diagram.

(b) Make all "sockets-to-pin-jacks" connections following pictorial diagram.

(c) Make all "pin-jacks-to-jack switches" connections following pictorial diagram.

(d) Make all "jack switches-to-3-position switch" connections following pictorial diagram.

(e) Make all "3-position switch-to-0 to 5,000 rheostat" connections following pictorial diagram.

(f) Make all "pin-jack-to-3-position switch" connections following pictorial diagram.

(g) Make all "pin-jacks-to-0 to 5,000-ohm rheostat" connections following pictorial diagram.

(h) Make all "pin-jack-to-pin-jack" connections following pictorial diagram.

(i) Connect the +BAT. OHMS pin-jack to the lug in the upper left of the panel, following pictorial diagram.

(j) Connect the lug located in the upper right of panel to corresponding point in 3-position-switch as shown by pictorial diagram.

Construction Procedure, III

(a) Connect metallized 750-ohm resistor, R2, between 3-position switch and 0 to 5,000-ohm rheostat, as shown in pictorial diagram.

(b) Connect 0.5-mf. capacitor, C1, between CAPACITOR and A.C.—D.C. METER COMMON pin-jacks as shown in pictorial diagram, inserting rubber sleeves in bare wires.

(c) Connect the .02-mf. capacitor, C2, between the C.G. CAP pin-jack and the corresponding contact in the universal-contact tube socket, as shown by pictorial diagram, inserting rubber sleeves in bare wires.

Resistor Panel Assembly, IV

A small, separate panel is used to house the multipliers and shunts for the meter. This panel is located on back of the meter, Fig. 3. To wire, proceed as follows:

(a) Starting with hole No. 1 and proceeding clockwise, bolt the following precision resistors on the resistor panel, as shown in Figs. 1 and 2 in the following order, inserting soldering lugs as shown by pictorial diagram:

Hole No. 1. 600,000-ohm multiplier resistor, R3;

Hole No. 2. 210,000-ohm multiplier resistor, R4;

Hole No. 3. 60,000-ohm multiplier resistor, R5;

Hole No. 4. 21,000-ohm multiplier resistor, R6;

Hole No. 5. 6,000-ohm multiplier resistor, R7;

Hole No. 6. 1,000-ohm multiplier resistor, R8;

Hole No. 7. 2,220-ohm shunt resistor, R9;

Hole No. 8. 740-ohm shunt resistor, R10;

Hole No. 9. 259-ohm shunt resistor, R11;

Hole No. 10. 74-ohm shunt resistor, R12;

Hole No. 11. 25.9-ohm shunt resistor, R13;

Hole No. 12. 11.1-ohm shunt resistor, R14;

(b) Connect all these resistors in series, as shown by pictorial diagram.

(c) Of the three small resistance spools which come with the meter, bolt to the panel the two that come together in holes "A," (R15, R16) and connect in series as shown in pictorial diagram. (Also see Fig. 3.) Insert remaining spool in hole marked "B" (R17) and bolt to panel.

Construction Procedure, V

(a) Complete the internal wiring of the 3-position switch by making the necessary connections between its own terminals, as shown by pictorial diagram.

(b) Solder the 6½-inch wire-leads to the terminals of the 3-position switch which are to be connected to the meter studs.

(c) Solder a 6½-inch lead to the 3-position switch terminal which is to be connected to the 11.1-ohm shunt resistor in resistance panel, hole No. 12, as shown by pictorial diagram.

(d) Insert Multimeter in the meter hole and bolt it to the panel with corresponding screws and nuts.

(e) Of the three nuts which come with each of the four meter studs, remove one from each stud and bolt the resistance panel to the meter studs. Insert one large soldering lug in each stud before screwing the nuts back on the meter studs. Tighten these nuts.

Construction Procedure, VI

(a) Connect the two small meter resistance spools, R15, R16, in the holes of the resistance panel (Fig. 3) to the soldering lug in the proper meter stud, as shown in pictorial diagram. Do the same with the remaining meter resistance spool, R17, in hole "B" of the resistance panel.

(b) Connect the open terminals of these three meter resistance spools to the proper 3-position switch terminals, as shown in pictorial diagram.

(c) Solder a 5-inch lead to one end of the 1,600 ohm resistor, R18, and insert rubber sleeves to cover bare wires; then solder to lug in meter stud. After this has been done, connect the

(Continued on page 501)

WHERE do you come in on this?

A Big Market

FIRST, do you recognize the fact that resistors constitute one of the most needed replacement items in radio—the long neglected part?

Money in Service and Sales

SECOND, do you know there's money in resistor service and sales the Ohiohm way?

Know What You're Buying

THIRD, do you realize that resistors must be able to conform with 10 important points of consideration in order to have genuine quality—from accuracy, permanency, quiet operation to such factors as mechanical strength, flawless appearance, and printed resistance values on the unit?

Then Get the Story of OHIOHMS



FIRST-AID KIT

furnished in 1-watt and 2-watt kits with most popular resistance values. Handy Ohm Dial furnished free with initial order.

SUPPRESSOR SETS for eliminating ignition interference on AUTOMOBILE RADIOS

for 4, 6 and 8 cylinder cars

Set contains condenser and necessary spark suppressors to meet all usually encountered conditions of automobile radio installation. New 50,000 ohm Ohiohms now available to fit Ford V-8.

Something New!

Cleanair
ICE-BOX and REFRIGERATOR DEODORIZER

a 50c item. Absorbs offensive food odors. Sell this when you give radio service. Write for details.

THE OHIO CARBON COMPANY CLEVELAND, OHIO

OHIOHM RESISTORS are made in Canada by C. C. MEREDITH & CO., Ltd., Toronto

• OHIOHM •

Samson "Mikes"

The microphone is the very "heart" of any short wave "phone" transmitter. SAMSON microphones represent the highest quality of workmanship and engineering design.



For example, consider the SAMSON Type F double button microphone. This microphone, priced at \$10.00, should appeal to hundreds of radio amateurs, whether the "mike" is to be used with an 80 meter phone set or one of the newer 5-meter phone transmitters. The SAMSON Type F "mike," although designed to sell at a low price, does not make use of the usual die-cast and cheap form of construction associated with low-priced microphones, but is constructed, (except for the diaphragm), exactly the same as the higher-priced, SAMSON double button microphones.

The Type F "mike" is just the model the average amateur station or experimental laboratory has been looking for. This microphone is designed for speech only, and is made of machined brass finished in chrome. The output level is approximately minus 33db. Net weight is 11 oz. Overall dimensions are 3 1/2" by 1/2".

With this microphone we recommend our microphone-to-grid transformer, type M.1.2 which sells for \$7.50, and our fifteen-foot shielded microphone cable which sells for \$2.50.

Special

As an introductory offer, we will for a period of 60 days send post free to any part of the world these three items totalling \$20.00 upon receipt of \$10.00 in cash by registered mail, money order or certified check, if sent to the Sales Manager.

Samson Electric Co.

Mfrs. Since 1882

Canton, Mass., U. S. A.

Earn Big Money

REPLACE BURNT-OUT and DEFECTIVE BALLASTS

MILLIONS of Sets including MAJESTIC and other standard lines need ballast Replacement **NOW**.

JOBBERS AND SERVICE ORGANIZATIONS—

Send for our plan outlining Ballast Replacement Market and Money Making Plan. Also Volume Control Replacement Data Book.

CLARSTAT MANUFACTURING CO., Inc.
285 N. 6th St. Brooklyn, N.Y.

SERVICE FORUM

(Continued from page 482)

knows personally of a certain midget receiver that started out as a six tube T.R.F. job, with the volume control in the R.F. screens and a single 45 output tube. In the space of five weeks the volume control was moved to the primary circuit, a new dial was installed, a phonograph jack added, the values of several bleeder resistors changed, and the output tube changed to push-pull '71 A's! Yet the same model number was retained throughout and the only "service" diagram ever issued was reproduced from the original engineering tracing!

Slight improvements in layout and wiring invariably suggest themselves during production, but not all manufacturers trouble to keep track of them. If the sets are not marked with serial numbers the changes are simply lost to the world. If the sets do bear serial numbers, and if the production manager and the service manager are on speaking terms, the changes are duly recorded.

Believe it or not, but there are actually set manufacturers who do not have diagrams or service data of any kind on receivers that they sell by the hundred. These firms are usually the ones that dispose of their receivers through department stores, furniture and chain stores, and they therefore have no concern for service problems or anything else that might happen after the sets leave their factories. Their so-called engineering departments usually have one copy of a schematic diagram, drawn on yellow paper with a hard pencil, and to let this get out of the plant would mean complete paralysis of the production line. Does this sound exaggerated? Not a bit. It's so common it's disgraceful. The writer knows of a large New York sales organization that had to put a Service Man on the job of tracing out the wiring of one of its most popular receivers, because the factory itself supplied a hookup that didn't match the set at all!

In writing to us for service information, please bear all of the foregoing in mind, and be patient with us. We think we are doing remarkably well considering the circumstances.

ROBERT HERTZBERG.

L. W. TUNER

(Continued from page 491)

Three Flechheim type M-D fixed condensers, 500 mmf., C6 to C8;

One Flechheim type M-L fixed condenser, .02-mf., C9;

Five Flechheim type SF-25 fixed condensers, .25-mf., C10 to C14;

One Clarostat type P18-3,000 variable resistor, 3,000 ohms, R1;

Two Clarostat type P10-100,000 variable resistors, 0.1—meg., R2, R5;

Two Clarostat type CGL variable resistors, 10 meg., R3, R6;

One Clarostat type FW-150 fixed resistor, 150 ohms, R4;

Four Clarostat type KCB-2 bakelite knobs;

Four Pilot UY-type base mounting sockets, for V1 to V4;

Three Sylvania type '35 tubes, V1 to V3;

One Sylvania type '24 tube, V4;

One National type B, VB C clockwise vernier dial;

Six shield cans (for inductances), 3 1/2 x 2 1/2 inches in dia.;

One Blau aluminum chassis, 10x14x8 ins. high (1/16-in. thick);

One Stettner "Capitol" model 310 cabinet.

AUTOMOTIVE INTERFERENCE

● Automotive interference has not changed within the past year any more than static reception has in the past twenty years—faulty ignition apparatus still causes interference, and electrical storms still cause static.

In installing an automotive receiver, do not become discouraged by interference: be sure that all leads are securely grounded and all connections firm. Of course, the usual spark-plug suppressors, distributor suppressor, and ignition-coil condenser are needed.

YOU GET THERE!



with RCA
INSTITUTES
radio training

NEW GENERAL COURSE IN RADIO combines Broadcasting . . . Sound Motion Pictures . . . Aircraft Radio . . . Marine Radio . . . Radio Servicing . . . Home and Studio Recording . . . Television Fundamentals . . . Electronic Tube Applications . . . Radio Code . . . Public Address Systems . . . and other radio and allied subjects.

No matter how much or how little knowledge of radio you have, there is a distinct advantage in taking this course. Let us give you details.

RCA INSTITUTES INC., DEPT. SW-2

New York School and Headquarters:
75 Varick Street, New York, N. Y.

Chicago School:
1154 Merchandise Mart, Chicago, Ill.

Please send with no obligation to me:

- () Full information on the New General Course in Radio. (All New York resident school only.)
- () Illustrated catalog and information about specialized resident school courses in radio and allied arts.
- () Information about extension course for study at home, together with illustrated catalog.

Name Age

Address

City State

SERVICE MEN!

Dumont Electrolytic and Paper Condensers are acknowledged best for replacement work; 20 years manufacturing experience behind products.

New and revolutionary static and aerial eliminator. LIST PRICE \$5.00.

Write for free catalog and prices.

DUMONT ELECTRIC MFG. CORP.,
453 Broome St., New York, N. Y.

The Original "GEN-E-Motor"

A fool proof dynamotor B battery eliminator for automotive and farm use. It is extremely economical, it does not require adjustment, it has no tubes, coils, or vibrator points to cause trouble; will not overheat, dipositively balanced, mounted on rubber, and is equipped with a double filter system that completely eliminates noise.

Write for interesting circular giving complete descriptions and prices for Pioneer Equipment.

PIONEER GEN-E-MOTOR CORP.
2251-R Lawrence Ave., Chicago, Ill.

PATENTS TRADE MARKS COPYRIGHTS

"Little Ideas May Have Big Commercial Possibilities"

PROTECT THEM BY PATENTS

Send for our Free book, "HOW TO OBTAIN A PATENT"

and valuable "Record of Invention" blank.

Prompt Service—Reasonable Charges—Deferred Payments

HIGHEST REFERENCES

VICTOR J. EVANS & CO.

Registered Patent Attorneys—Established 1898

650-BB Victor Building, Washington, D. C.

Knowledge Pays Big

We teach you how to build and operate Radio Treasure Finders and how to locate Metals Underground. Fascinating, Scientific, Accurate. Full details for 3c stamp—Write TODAY.

Exchange, P.O. Box 607-W El Monte, Calif.

SERVICEMEN-DEALERS

Send 25c for our Handbook and Catalog

Complete Stock of NEW Radio

Replacement Parts

Hard to Get Parts—We have them. Send us your repair work for estimate.

Grant Radio Laboratories

6521-C South Halsted St., Chicago, Ill.

Announcing

the

BULLETIN



THE BIGGEST NEWS-MAGAZINE IN THE RADIO INDUSTRY

Issued Monthly for Radio Service Men

This new magazine is filled with interesting service information; plans of the Association; Service Men's experiences; answers to inquiries about servicing; hints on making extra money in the servicing field, in short, it is a magazine written for and by members of the O. R. S. M. A. It is the voice of the Association in which the problems and suggestions of the individual members are presented for review and discussion among the fraternity. It is a magazine for, of and by the Service Man, edited by the staff of RADIO-CRAFT Magazine, sponsors of the OFFICIAL RADIO SERVICE MEN'S ASSOCIATION.

In appearance this BULLETIN is made up in the style and size of a tabloid newspaper. It contains up-to-the-minute service information. A partial contents of the first issue is found below:

- Editorial:—The purpose of the O. R. S. M. A. BULLETIN.
 Messages from Service Managers of large Radio Set manufacturers to O. R. S. M. A. members.
 Servicing experiences—unusual service cases and their method of handling.
 Descriptions of service equipment—by members.
 What the Service Man should charge—various angles of this vital question.
 A sermon to set owners—Beginning the War on free service "Gyps."
 The Service Man's Own Forum—Letters on all subjects pertaining to the Association.
 Electrifying and Modernizing old receivers as a source of income to the Service Man.
 Making Money at Servicing—The ways in which established Service Organizations advertise and otherwise extend their sources of income.
 The Question Box—questions and answers of servicing, questions of general interest.
 Employment Service—ads inserted by members looking for employment and companies looking for men.

Subscription Rates for the O. R. S. M. A. BULLETIN

O. R. S. M. A. Members		Non-Members
50c	one year	\$1.00
\$1.00	two years	\$1.75
\$1.50	three years	\$2.50
\$2.00	four years	\$3.00
\$2.50	five years	\$3.75

Price of Single Copy 10c

Subscription Blank

Executive Secretary O. R. S. M. A.,
 98 Park Place, New York, N. Y.

Enclosed find my remittance of \$..... for which please enter my subscription to your BULLETIN for years.

- I am a member of The Association and my Membership Certificate number is.....
 I am not a member, but would like to receive your application blank to join the O. R. S. M. A. (no fees—no dues to be paid by me).

Name.....

Address.....

City..... State.....

P.A. SYSTEMS

(Continued from page 477)

directly, without ringing the phone and then asking the person who answers to call the desired person. With factory efficiency experts continually eliminating lost motion, this feature can be played up to good advantage.

A quick trip through a prospect's office or factory, which can usually be arranged without trouble if the Service Man asks for it, will enable the latter to estimate the required number of speakers and their placement for best results. As remarked in these articles before, you can lose nothing by making a survey of this kind, and all the prospect can do is say, "No."

Do not fail to carry a completely mounted desk microphone with you when making calls on firms. There is a peculiar, intangible fascination about the "mike" because it is pictured so prominently in photos of broadcasting activities. People are interested in seeing one close up "in the flesh," in handling it, and in pretending to talk into it. This may sound childish, but it is quite true. Carry the mike casually in the crook of your arm, so that every one can see it. When you get in to see the purchasing agent or the head of the firm, put it plumb in front of his nose on his desk. He won't object at all; in fact, he'll probably grab it immediately and begin asking questions about it. Be sure to pick out a bright, shiny mike, with plenty of suspension springs and the cord all connected. The effectiveness of this little piece of sales psychology, which has been used by many Service Men, is quite surprising. (And how!—Editor.)

Since there is not as much dispersion indoors as outdoors, amplifiers of comparatively small size and capacity may be employed with good success. A single '45 output tube will comfortably handle one, two, or three small dynamic speakers, and will operate economically. A typical outfit that is finding widespread application is illustrated in the front part of this article. It comprises a double button microphone in a ring-type desk stand, a control box, a Loftin-White direct-coupled audio amplifier using a 57 feeding a '45, and either one or three dynamic speakers, complete with cabinets. The circuit arrangement, which will interest technicians, is shown in detail and can easily be followed. The amplifier unit proper it built up on a pressed steel chassis, and measures only 6 by 8 by 7 inches overall. It may be placed under a desk or table or behind the telephone switchboard.

The amplifier is turned on in the morning and left running all through the business day, the unit having been designed for continuous service. The operator then simply flips the mike switch "on" when she wants to talk, and she does not have to wait for the tubes to warm up. The speakers respond instantly and no time is lost. A gain control is mounted in the control box; once set, this usually requires no further handling.

Of course there is nothing to prevent the use of a phonograph pick-up for the reproduction of phonograph music during lunch hour, or at the discretion of the "boss." As remarked in the first article of this series (December, 1932, RADIO-CRAFT) a few minutes of music during afternoon recreation periods, in factories, is a big factor in building up employee morale.

RADIO-CRAFT CALL SYSTEM

Many people preach a lot, but don't act very much. RADIO-CRAFT has been describing P.A. amplifiers for a long time, and now we are pleased to announce that we are installing an inter-office call system. Briefly, a microphone is to be installed in the office of the Editor-in-Chief, and speakers placed in each of the offices of the various Editorial Departments.

When the Editor wants to speak to one of the department, he merely calls his name, and the response is almost immediate—no lost motion. Incidentally, the amplifier arrangement used is the same as described in our December issue entitled, "A Battery-Operated, Portable P.A. System," by Clifford E. Denton.

The amplifier may be used for so many purposes that a complete list is almost impossible. The use to which the equipment is being put is one that has been suggested by us for a long time, and which few men seem to appreciate.

However, details will appear later.

Test Sets This Simpler Way!



\$15.00
 NET TO DEALERS
 List \$25.00

Readrite

TESTER NO. 710

THIS new and improved tester is equipped with a practical selector switch for checking all parts of the tube circuit by connecting to the set sockets. It is so designed that selection can be quickly and accurately made for testing voltages of plate, grid, cathode, suppressor grid and screen grid. Plate current, filament volts, line and power supply volts are also measured.

A battery is used for the continuity testing of transformers, chokes, etc. Capacity and resistance charts are furnished showing use of instruments for testing condensers and for measuring resistance up to 100,000 ohms.

A Remarkable Instrument At A Remarkable Price

Both A.C. and D.C. filament voltages are accurately measured on the one meter. Contains new wiring with added 7-hole socket. It is equipped with a small diameter plug-adaptor for testing in new sockets.

If your jobber cannot supply you, we will ship the No. 710 Tester directly to you—when remittance accompanies your order at the dealer's net price of \$15.00.

Readrite Meter Works
 38 College Ave., Bluffton, Ohio

MAIL COUPON NOW

READRITE METER WORKS,
 38 College Ave., Bluffton, Ohio.
 Gentlemen:
 Please send me information about Readrite No. 710 Tester. Also catalog of other servicing instruments.

Name.....
 Street Address.....
 City..... State.....

SERVICEMEN & Experimenters

Here are a few of the thousands of articles we have to offer at these very low prices. All merchandise is brand new in original boxes or cartons. Take advantage now!

Sangamo—Transformers—Type AX. Reg. \$6.00	\$.69
Sangamo—Push Pull, Type BX. Shielded Type	
Type IIX. Reg. \$13.00	2.79
Baldwin—Type C Headphones. Mica diaphragm.	2.89
Brandes—Superior Headphones	1.39
Erpes—German light weight phones	1.35
Elkon—Tapering Trickle Charger. Reg. \$10.00	2.19
Elkon—Replacement Dry Rectifiers	1.29
Kuprox—1 Amp. Replacement Rectifiers	1.25
Weston—No. 506 Voltmeters. Reg. \$7.00	1.79
Aero—Short Wave Coils. List \$12.00	3.63
Radiola—100A Magnetic Speaker	4.89
Radiola—103 Magnetic Speaker	3.89
Radiola—106 Dynamic Floor Tapestry Model	14.89
Radiola—106 Dynamic D. C. chassis 300 V. Field	4.39
Bodine—Electric Phonograph Motor. Reg. \$35.00	7.95
Ansonia—Magnetic Speakers, Mahogany Cabinet	4.75
Peerless—Cathedral Dynamic Speaker. List \$75.00	11.89
General Electric End Table Phonograph	14.89
Tobe—Dry "A" Eliminator 2 1/2 ampere	6.89
Universal Baby Microphone. Reg. \$7.50	2.59
B. B. L.—Giant Motor Speaker Chassis	4.85
B. B. L.—Medium Speaker Chassis	2.69
Eagle—Tone Control. Reg. \$3.50	.85
Thordarson—R171 "B" Blocks	2.89
Stromberg Carlson—No. 3A Audio	.97
Stromberg Carlson—No. 4C Audio	1.29
Stromberg Carlson—No. 5 Output Audio	1.65
Stromberg Carlson—No. 4B Speaker Unit	.95
Stromberg Carlson—No. 3A Phono Pickup with volume control and transformer	7.39
Eby Assorted Marking Binding Posts	.05
Remler Intermediate Transformer Type 600	.69
Remler Variable Condensers .0005 Cap.	1.95
Hammerlund No. 250 Ma. R. F. Chokes. Reg. \$2.25	.95
Kolster A. C. No. K20, 7-Tube Table Model Set. List \$135.00	14.85

Hammarlund parts at tremendous savings. What do you need?

We specialize in standard replacement units for service work.

We carry a large assortment of HONEYCOMB coils and mounts.

Silver-Marshall parts at low prices. Ask us!

We issue no catalog—We carry one of the largest stocks of Radio-Parts in the country and can fill your orders at lower prices than elsewhere.

Send us your order direct for anything and everything in Radio—include 20 per cent deposit with order. We ship anywhere C. O. D. plus postage.

We invite O. R. S. M. A. members to take advantage of our special discount.

43rd Street Radio Shop
124 East 44th Street (at Lexington Ave.)
NEW YORK CITY, NEW YORK

Makes Your Radio BEHAVE!

Less than one hour of high line voltage will overload vital parts of your radio—causing crackly noises. AMPERITE automatically regulates voltage—prevents noises and burnouts.

Send \$1.49 to Dept. RC-2 for sample and sales helps

AMPERITE CORPORATION
561 BROADWAY, NEW YORK

AMPERITE
VOLTAGE CONTROL

SERVICEMEN

MAKE MORE MONEY

Transformers Rewound or built to order. Speaker Field Coils wound for all types of Speakers **50c up**

GRAPHITE VOLUME CONTROLS REBUILT
Guaranteed like new. 25% to 50% saving

5 Hour Service
Prices on request

PEMBLETON LABORATORIES
921 Parkview Ave. Fort Wayne, Indiana
17 years in design of coils and transformers

FIDELITY CONTROL

(Continued from page 476)

voltage with respect to frequency; or, in other words, H illustrates the gain of the circuit with frequency. H is the curve with large Rp; when the grid voltage is -3 and the suppressor bias is zero, for example. We want to know what happens to the curve when the suppressor bias is changed to -35 volts and Rp is thus made small. When Rp is small, Z becomes small, consequently curve H will move to H', the new resonance curve due to the increased negative suppressor-grid voltage.

These two curves tell the whole story; which is, that as the suppressor voltage on the 58 is varied, the gain of the plate circuit drops and broadens. It is this broadening that decreases the tendency toward sideband cutting, and accounts for the better fidelity response.

The reader will note that exactly the same sort of thing was done in earlier superheterodynes; only there, a switch threw additional resistance into the tuned circuit to secure the same effect. More accurately, of course, we may speak of the 58 as a selectivity control rather than a fidelity control.

Now we can consider what the changing Gm will mean. In the first place, Gm actually decreases as the suppressor bias is increased, even though Rp also increases. This means quite simply that the gain of the tube is decreased. Therefore, EgGm will be smaller and the response curve, H', will drop down correspondingly all along its range. The shape of the curve, of course, will not change, but the overall gain of the stage will have decreased. Actually, if the bias were to be increased all the way to 40 volts, the decrease in stage gain due to Gm variation and change in impedance would be the same as for that secured by backing the bias on a 235 down to about 40 volts.

It will be obvious that at broadcast frequencies the fidelity control will not be very effective since the usual tuned circuit there is already rather broad. Similarly, if a high I.F. is used in the superheterodyne or if the resistance already in the tuned plate circuit is rather large, the fidelity control effect is lessened. In supers with an I.F. of 115 kc. or so, such as intended for the European market, the 58 is a real blessing because side-band cutting there is very noticeable even with only one I.F. stage. As yet, however, most manufacturers, in their hurry to get sets with the new tubes on the market, are tying the suppressor-grid to the cathode and letting the automatic quality feature remain dormant. This condition is probably temporary and some enterprising manufacturer will probably introduce a set with automatic tone control very shortly.

It must not be thought that the characteristic of the 58 that we have been discussing eliminates the usual manual tone control. The 58 gives real control; the usual tone control usually only eliminates the higher frequencies.

One more point invites discussion. From Fig. 2 we note that if the control-grid voltage is varied to -10 volts while the suppressor bias is being increased to -40 volts, the plate resistance variation is considerably reduced; the range is only 800,000 to 250,000 or approximately 3:1. The correct way, then, to vary the grid and suppressor voltage, if they are to be varied simultaneously, would be to allow the control bias to change slowly and only by a few volts while the suppressor changes at a faster rate and to a greater amount. The suppressor will supply the attenuation that the lesser grid variation loses.

1 Volume RADIO Encyclopedia

Double the size of the First Edition!

This 2nd Edition, S. Gernsback's Radio Encyclopedia is by far the most useful book in Radio Literature. It is designed for practical use and gives you instant information on everything in Radio.

The fact that 30,000 Radio Men have one or the other edition of S. Gernsback's Radio Encyclopedia in their homes, proves that it is an absolute necessity in the Radio Trade. EVERY RADIO MAN SHOULD OWN THIS VALUABLE VOLUME.

What the New, Second Edition Radio Encyclopedia Gives You

The explanations—or, rather, definitions are not in brief outline form like those of an ordinary dictionary, but they give in fullest detail, and at considerable length, the meaning and application of every word, phrase, general and special term used in the science of radio. Every topic is written in plain, everyday English, easily understood by anyone.

Hundreds of definitions in the book are illustrated by drawings, photographs, diagrams, or charts. Just look up as you would in a dictionary, the word or phrase about which you are seeking information. Every page is key-indexed for convenience and speed in locating any definition. All the subject matter is arranged in alphabetical order.

This greatly enlarged Second Edition Radio Encyclopedia should be used by everyone in radio. It answers all radio questions,—increases your knowledge and saves time. It covers every known radio problem. It is a gold-mine of facts for every radio man.

2,201 RADIO DEFINITIONS; 1,253 TECHNICAL ILLUSTRATIONS; 34 TABLES AND CHARTS; 21 PAGES OF APPENDIX; Red Morocco-Keratol Flexible Covers; Printed on strong ledger paper, loose-leaf arrangement.

NEW SELLING PLAN

In order to allow you to inspect the volume and really appreciate what you are buying, we will send it to you with the privilege of inspection. When the express man brings you the book, look it over. If you like it, pay him the purchase price of the book, plus postage. If you do not like it, just tell the express man to take it back. You won't be out one penny.

352 pages
9x12 inches
Weight 3 lbs.



Mail Coupon for this Book!

S. GERNSBACK CORPORATION,
98 Park Place, New York, N. Y.

Send me one copy of the new Second Edition S. Gernsback's Radio Encyclopedia with the privilege of inspection. If I like the volume, I will pay Expressman \$3.98 plus shipping charges.

Name

Address

City..... State.....

American Bosch VIBRO POWER RADIO

Only American Bosch has vibro power, a newly discovered super force in radio. Write for our price list; we can save you 25% on your purchase.

WE SELL THE AMERICAN BOSCH, MAJESTIC, SIMPLEX and PHILCO RADIOS AT BARGAIN PRICES.

McGUIRE DISTRIBUTING CO.
Doeville, Tenn.

N. R. I. FUNDAMENTAL RADIO COURSE

In the December issue of Radio Craft lessons IFR to 35FR of the fundamental radio course offered by the National Radio Institute were reviewed in detail. These lessons are supplemented by a second series of booklets and a collection of service sheets.

For advanced students a special course in radio mathematics is offered. This is reviewed under the numbers 9SB to 12SB.

Following are reviews of the individual books of the entire series:

- 1 SB *Radio Inventions*—This book covers the science of developing and protecting profit-making radio inventions, and includes a list of urgently needed devices for radio. What not to invent is stressed in this book equally with the desirable inventions.
- 2 SB *Radio Service Men's Tools and Their Uses*—From a can of oil to the unique Jewell Universal Instrument, which performs the function of eight meters, Service Men's tools are described in this book. It is practical in scope and tells how the various necessary tools are used.
- 3 SB *Commercial Radio Condensers*—This book carries on the work of previous lessons on condensers by illustrating the qualities, operation and field of usefulness of a number of well-known modern condensers.
- 4 SB *How to Build a Broadcasting Station*—For the future owner of a broadcast station, for the radio worker who is employed in building a station, and the broadcast station employee, this book details the principles and practice of construction. Every phase of the station is covered, from the input apparatus to the studio.
- 5 SB *Antenna For Broadcast Reception*—(Book 1) This book carries the reader to the receiver, thoroughly covering the design and construction of antennas for radio reception. The placing of aerials on residential and commercial buildings is covered in detail.
- 6 SB *Antenna for Broadcast Reception* (Book 2)—This book completes the study in Book 1, going more thoroughly into the minor details of antenna construction and set-up.
- 7 SB *Set Analyzers*—The theory of the detection of troubles in radio circuits is explained in this book, and the use of the set analyzers to detect the nature of such troubles is described. The various types of defects are covered and typical set analyzers are described.
- 8 SB *Decibels—Audio Amplification*—The science of measuring sound intensities is covered in this book. The mathematics of decibels

and the calculations of power required for sound intensities are described. Audio response curves, possible sources of audio distortion and push-pull amplification are subjects also included.

- 9 SB *Radio Mathematics—The Use of Arithmetic in Radio*—The radio expert deals constantly with figures. This book is a reference book on various arithmetical problems and includes tables of logarithms.
- 10 SB *Radio Mathematics—The Use of Algebra in Radio*—This book is a simple course in algebra for the beginner, with special emphasis on the equations that occur in radio problems.
- 11 SB *Radio Mathematics—The Use of Geometry in Radio*—Continuing the mathematics course, this book is an elementary study of geometric figures, especially those that occur in radio problems, such as the figuring of impedance, inductance, capacitance, etc.
- 12 SB *Radio Mathematics—The Use of Trigonometry in Radio*—As a final part of the Service Man's understanding of radio mathematics this book teaches how to solve problems that occur in the solution of all alternating current circuits. Numerous examples illustrate the text.
- 1 SM *Trouble Shooting in D.C., A.C. and Battery Sets*—This is a reference book that outlines all of the possible signs of trouble in radio sets, and what the possible cause of each can be. A second section deals with the means of correcting each trouble when discovered.
- 2 SM *Trouble Shooting in D.C., A.C. and Battery Operated Sets*—This book brings the trouble shooting down to definite sets, with special emphasis on the testing of continuity in the various circuits of receivers.
- 1 JS *28 Tested Ways For Making Extra Money*—Here are a goodly number of little or big jobs the Service Man can do to improve the reception of various sets and thereby earn money for himself. The book covers work on antennas, tone control, wave traps, installing special loudspeakers, curing "motor-boating," installing interference eliminators, etc.
- 1 SS to 6 SS and 1 SSC *Service Sheets*—A fairly complete portfolio of service data on the better known receivers. One section covers American sets and another is devoted especially to sets of Canadian manufacture. Each sheet gives operating data as well as a complete schematic diagram of the set.

"AN OWL AND A PUSSY CAT—"

● "An owl and a pussy cat went to sea—"
If you want to go to sea—or sleep—and listen to your favorite program while falling, why the radio owl pictured below will do the trick for you easily. Merely plug the owl in the light line and the radio in the owl; then set the owl for any time within two hours after setting, and the wise one quietly does its work.

Suppose Radio Jr. wants to play for a while before going to bed, and daddy wants to play at the same time; merely set the owl, and in a predetermined time the light in the child's room goes out—simple, eh?

Have you a little neon sign over your store? If you have, and want to shut it off, say an hour after you close up, just connect the

wise old owl, and he will shut it off for you. This owl is sturdily constructed, has no parts to wear out, nothing to wind—but a lot to do. It is a product of the Universal Microphone Co.

FILTER CONDENSERS

● Watch those filter condensers. Many sets now on the market do not use a bleeder resistor across the output of the rectifier system. Instead a high resistor is placed across the output of the filter system, which serves the same purpose as the 15,000-ohm units formerly used to the exclusion of all others, in order to prevent the output voltage to rise to an abnormally high value.

As may sometimes happen, this resistor goes "west" and the Service Man "forgets" to replace it. He merely disconnects the defective unit and, since the set works O.K., leaves things as they are—a good procedure, sometimes.

The customer turns on the set, a p-l-o-p is heard, and all is quiet on the western front. Moral—be sure there is a resistor connected across the "B" unit to keep the voltage steady.

Electrolytic condensers are now in vogue. When testing receivers by means of resistance measurements, an erroneous reading may sometimes be obtained if electrolytic condensers are in the power unit and the power unit affects the readings. These apparent erroneous results are due to the fact that the resistance of electrolytic condensers is low when the applied voltage is reversed. To remedy the situation, then, reverse the polarity of the ohmmeter leads and take a second reading. The higher reading is correct.



COME TO SUNNY CALIFORNIA

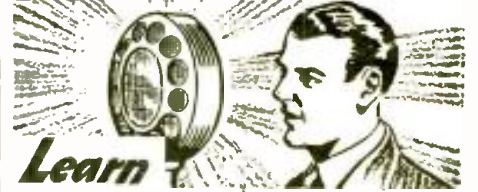

TELEVISION-RADIO TALKING PICTURES

In just a few years, Radio has become one of the world's leading industries. Talking Pictures have brought new life and opportunity to the Movies. Now, Television is here with a promise of growth and activity so great that it cannot even be estimated. Come to Los Angeles—most active Radio center in the world—and learn these fascinating Trades. You can be one of those to reap the harvest.

BUT—YOU MUST BE TRAINED

Times are getting better. The worst of the depression is over. Thousands of new jobs will call for TRAINED MEN. Will you be ready? Regardless of the Times, the Trained man wins. He always has and he always will. Take that fact as a guide and your future is assured. Wonderful opportunities are open before you.

Get the Best Training Your Money Will Buy

Naturally, you want the best, and most complete training you can secure. Analyze—Investigate. Your whole future depends upon it. For over 28 years, National has been training ambitious men by our own practical shop method. Our graduates are our best recommendation.

Life Scholarship Insures Thorough Instruction

You are not hurried through your courses at National. You are given a Life Scholarship when you enroll, which means that you can go just as fast, or take as long as you wish to complete your training. The main thing is that you master every phase of your instruction, step by step.

ACTUAL EXPERIENCE—on modern equipment

There is no DUMMY equipment at this wonderful institution. It is all "hooked-up", ready for you to use in learning your Trade. You learn Television on actual Television Transmitting and Receiving equipment. You take part in operating our own Radio broadcasting station W6YF. In Talking Pictures, too, you learn on actual equipment, right in National's Student Talkie Theatre.

EARN ROOM AND BOARD

Spare time jobs while at school. We help you get a job to pay living expenses while learning. So if you are short of money, don't let that hinder you from enrolling. 75% of our students are earning their living expenses while attending school now. We also allow your Coach Railroad Fare to Los Angeles.

Special New Course—Radio Broadcast Technician

Finest studio in West—sound-proof walls, broadcasting big programs—just like the most famous stations. 5 separate studios. Special course given without extra cost to students who enroll immediately. We broadcast over our own station and also by remote control. You actually learn operating the equipment, qualifying for important technical jobs.

Ask for Details

Send coupon for descriptive literature. You use it to become thoroughly acquainted with this great school. You will find the facilities here a positive revelation. Get new book, which gives you all the facts in story and pictures—SEND COUPON AT ONCE!



Oldest Trade School in the West Est. 1905 25,000 Graduates

NATIONAL RADIO & ELECTRICAL SCHOOL—Los Angeles
Dept. RC-2, 4006 So. Figueroa St.
Send Book and full details of Courses.

Name.....
Address.....
City..... State.....

LYNCH ANTENNA SYSTEMS

\$5⁰⁰
LIST
Complete

More Profit
Lower Price
Easier to Sell
Easier to Install
Better Results

Eliminates Man-made static and permits the use of several receivers on a single antenna.

Dealers—Servicemen

If your jobber cannot supply write his name and address on your letterhead and attach this ad with check for \$3.00. Kit will be sent prepaid and sale credited to your jobber.

Interesting literature describing the many other popular Lynch products sent on request.

LYNCH MFG. CO., INC.
1775 Broadway, New York, N. Y.

Be a TELEVISION EXPERT



During the next few years, thousands will become rich in Television, the amazing new major industry. Will you be one of these? There is only one way for you to get into Television and that is with specialized training. Television experts are needed right now and this marvelous new business has hardly started. If you are over 17 years of age, send your name and address for full information about our plan whereby you may step out of the world's greatest Television School—occupying the three top floors of Missouri's tallest skyscraper—into a high pay position. Write Today.

Sid Nozi, President
FIRST NATIONAL TELEVISION
2901 Power & Light Bldg.
Kansas City, Missouri

FREE

13th ANNIVERSARY RADIO CATALOG



124 pages containing thousands of the greatest radio and electrical values at real bargain prices.

Send for your copy now!

AMERICAN SALES COMPANY
Wholesale Radio Distributors
RC-44W, 18th St., N. Y. C.

Study RADIO in CANADA

A start in Radio Guaranteed or your money back. Course covers Radio, Television, Sound Amplification and Telephony. Practical work material supplied. Preparation for Government and Service examinations. Home Study, Day or Evening Classes. Write for booklet.

RADIO COLLEGE of CANADA
Limited

310 Yonge Street Toronto, Canada

FREE RADIO CATALOG

Write for this Big Free Book Today
The most complete line of radio sets, service men's supplies, replacement parts, test equipment at the lowest wholesale prices

ALLIED RADIO CORPORATION
835 W. Jackson CHICAGO

A 3-TUBE, BATTERY OPERATED, 7½ WATT P. A. AMPLIFIER

(Continued from page 478)

(It has even been suggested that some of our "drugstore cowboys" may use this system to advantage—with a saving of lungs and horn.—Editor.)

It will be noted from the accompanying illustration (Fig. B) that this "B" eliminator is directly fastened to the amplifier chassis proper, greatly facilitating its complete installation in any automobile or truck. There is provided a sufficient length of heavy gauge, stranded, and durably rubberized, insulated twisted battery cable and two powerful gripping battery clips for the connection to the battery terminals.

Three low priced tubes are all that is required, viz: a '37 and two 42's.—these tubes are of the heater-type construction, and consume in all 1.6 to 1.75 amps., at 6.3 volts. Their filament supply naturally comes from the storage battery proper, and, of course, does not affect the current consumption of the "B" eliminator itself,—the total current drain is, therefore, approximately 7½ amps., exclusive of any speaker field excitation provision.

The circuit is unusually simple, but notwithstanding that, it is remarkably efficient; it is shown in schematic Fig. 1.

The input system of this amplifier is "universal,"—it consists of an input twin jack, the terminals of which connect to ground and through a universal 500,000-ohm volume control to the grid of the first stage, '37 tube. If you intend to employ a single or double-button microphone, you will require a suitable microphone input transformer, the secondary terminals of which are connected to this input jack. This also holds true for a phonograph pick-up transformer. No input transformer is required if a high impedance phono, pickup is employed. If either or both of these input transformers are employed, it is advisable to mount them within an external shielded "control box" to eliminate any losses. However, if unusual shielding and correct transformer angular placement is employed, these input transformers can be mounted underneath the amplifier chassis, if desired. The output of this high-gain, 1st A.F. stage is fed through a conventional input push-pull transformer to a stage of two '42 pentode tubes, producing an undistorted output of 7½ watts, employing in all, only three tubes! The quality of reproduction on either microphone, phonograph, or radio tuner inputs is unusually realistic and pleasing, free of A.C. hum, or any disturbance. The amplifier itself is absolutely stable in operation, and will require a minimum servicing. A tone control is included, as is a five-prong speaker socket, three terminals of which are connected through a speaker cable to its output transformer (on the speaker), the other two carrying 6 volts D.C. to a 6-volt dynamic speaker field, should one be employed,—this 6-volt lead provision further simplifying the installation. No external "C" bias batteries are required, as all bias provisions are self-contained.

The single switch, SW.-1, is the only switch required, controlling at the same time the filament supply, the motor generator, and the speaker field excitation. The "handful" of parts are mounted on a sturdy, cadmium-plated chassis measuring 14 inches long, 7¾ inches wide, and 3½ inches tall. (The "B" eliminator cover rises 6 inches above the chassis surface, and being 1-inch higher than the top of the tubes, protects them against breakage.) Its total weight, including the "B" eliminator, is only 21¼ lbs. There is ample room underneath the chassis, thereby making it a matter of but a few minutes to do all the wiring.

It is suggested that a 6-volt D.C. field dynamic speaker be employed, for maximum volume reproduction; such fields each draw from .4-ampere to 1.375 amperes, which is required for 6-volt photophone, dynamic speakers. Incidentally, the latter mentioned speaker will actually produce the full output of 7½ watts without rattling. If desired, 2, 3, or 4 dynamic speakers can be operated from this amplifier. You, of course, can also employ the new permanent magnet dynamic speakers, which require no field current at all; for that matter, up to 16 magnetic speakers could be employed, if so desired.

In conclusion, we strongly urge our far-seeing readers to investigate the really lucrative field

(Continued on following column)

When You Buy the Alan S.W. Receiver —YOU GET—

Compass—1. Frequency and wave control. Multi-Mu sensitivity. Low background noise. Superior audio oscillation control.



Full A.C. or D.C. operation. Absolute broadcast A.C. operation. In-ear phone audio for quietest phone signals. Mica insulation throughout.

Alan 2-B Battery Set including one type 32 Multi-Mu tube and one 32 Pentode tube. \$12.25
Build-it-Yourself Kit. 10.15
Kit of 2 Tubes. 1.55
Alan 3-B Battery Set including 2 type 34's and one type 33. \$15.50
Kit Price. 13.75
Kit of 3 Tubes for above. 1.50
Alan 4-B Deluxe, using 2 type 34, one type 30 tube and one type 33. \$19.50
Kit Price. 17.40
Kit of 4 Tubes. 3.10
Alan III A.C. 4 Tube A.C. Receiver using 2 type 58 Tubes and 1 type 56 and 1 type 80. Absolutely humless, ready to plug into 110 V. A. C. line. \$23.50
Kit Price (with directions and 100.00 Set of Tubes for Alan IV Kit Guaranteed Tubes. 4.05

ALAN RADIO CORP.,
83 Cortlandt St. New York, N. Y.

SAVIL 748

THE NEW D. C. SUPERSET

Using the new No. 18 D. C. superpower output tubes as described in the December Radio-Craft Tuning Range 340-2500 Kc., 530-120 meters. An exceedingly sensitive four-stage seven tube D. C. receiver having the big reserve of undistorted power output performance found only in the best A. C. sets.

"Without any hesitation, we say this is one of the very best D. C. receivers that has come to our attention". . . . Editor Radio-Craft

Now on demonstration at 71-73 Grand Street
Readers of Radio-Craft Write for Special Discounts

SAVIL RADIO ENGINEERING CORP.
71-73 Grand Street New York, N. Y.
Manufacturers of High Grade Receivers and Power Amplifiers.

NEW Autocrat Jr.

New Super Phonic Tubes

1-258, 1-257, 1-247, 1-250, R. C. A. (low 0) Build-up Kit \$10.95
V. A. C. 40 cycle
Size 12½ x 7¼ x 9½—weight 12 lbs.
Easily assembled. Full instructions. Walnut Cabinet. Dynamic speaker. Complete with all parts. Direct from Mgr. Send \$4 deposit, balance \$8.15 C. O. D. Complete assembled, \$12.95. A source build and sell these radios. Send for illustration 6 Tube Auto Radio.



AUTOCRAT RADIO CO.,
3655 N. Hamilton Chicago, Ill.

A 3-TUBE, BATTERY OPERATED, 7½ WATT P. A. AMPLIFIER

(Continued from preceding column)

offered by these power amplifiers; for, it is our opinion that a new industry, that of automotive sound amplification, is in its embryonic formation. It would be wise then, to establish yourself in your county as an official source of supply for such devices, using your own car amplifier as your best sales medium.

Parts List

- One—Coast-To-Coast Chassis 14 in. x 7¾ in. x 3½ in.;
- One—Coast-To-Coast D.C. Motor generator, 265 volts at 85 ma., 6 volts input;
- One—Electrad 0-500,000 ohm potentiometer V1;
- One—Coast-To-Coast tone control Multiple Condenser, V2;
- One—Lynch 2,700 ohm, 1-watt resistor, R1;
- One—Lynch 200 ohm, 2-watt resistor, R2;
- One—Lynch 10,000 ohm, 1-watt resistor, R3;
- Two—Coast-To-Coast 8 mf. electrolytic, 500-volt condensers, C1, C2;
- One—1 mf., 200 volt condenser, C3;
- Four—Cinch wafer sockets, S1, S2, S3, S4;
- One—Heavy battery cable with 2 large clips;
- One—S.P.S.T. switch, 10 amp., 12 volts, SW.1;
- One—Coast-To-Coast push-pull input transformer, T;
- One—Eby twin jack;
- One—Eby type P.B. binding post;
- One—Littelfuse fuse block and fuse, ¼ amp.;
- One—'37 tube;
- Two—Sylvania '42 tubes
- Miscellaneous hardware, wire, etc.

SUPREME "56"

(Continued from page 495)

other end of the resistor to HI. RES. V.M. COMMON pin-jack.

(d) Complete all connections between the 3-position switch and meter stud lugs, as well as between the 3-position switch and the open end of the 11.1-ohm shunt resistor, R14, in hole No. 12 of the resistance panel. Follow the pictorial diagram closely.

(e) Complete all connections between pin jacks, multiplier, and shunt resistors on resistance panel, as shown by pictorial diagram.

Construction Procedure, VII

(a) Connect analyzing cable leads to the corresponding pin-jacks located in the upper center of the panel. Be sure to follow the pictorial diagram.

(b) The analyzer is now completed. It is suggested that a continuity test be made of the entire hook-up, following either the point-to-point or the pictorial diagrams. Check the number of wires connected to every part in the layout, and compare with number shown at each corresponding part in the pictorial diagram.

(c) Screw the rubber bumpers on the case, 4 on the bottom of the case and 2 on the left side. Screw the slip-hinges on the side of case and case cover. Screw two rubber bumpers on the left side of the case cover.

(d) Put the panel on the carrying case, placing the analyzing plug cable in the groove cut on the inner side of the cable compartment for providing the analyzing cable outlet. Screw the panel on the case brackets.

(e) Three 1.5 V. batteries are located on the upper right side of the case; insert batteries, bottom first, one at a time. Screw the battery plate back on the case and the analyzer is now ready for resistance measurements.

Conclusion

We believe that the above procedure will acquaint the builder with the circuits of the Model 56 well enough, so that he may do his own repairing in case of need. Each resistor is separately calibrated, so that any one of these may be replaced without upsetting the meter calibration. This also applies for any other part used in building the 56, so that in case of need, the necessary parts may be ordered and replaced with the assurance of the same smooth and accurate performance.

Valuable construction hints, operating data and large blue prints may be had by those who obtain the entire kit from the Supreme Instruments Corporation.

List of Parts

- One rheostat, 0 to 5,000 ohms, R1;
- One metallized resistor, 750 ohms, R2;
- One multiplier, 600,000 ohms, R3;
- One multiplier, 210,000 ohms, R4;
- One multiplier, 60,000 ohms, R5;
- One multiplier, 21,000 ohms, R6;
- One multiplier, 6,000 ohms, R7;
- One multiplier, 1,000 ohms, R8;
- One shunt, 2,220 ohms, R9;
- One shunt, 740 ohms, R10;
- One shunt, 259 ohms, R11;
- One shunt, 74 ohms, R12;
- One shunt, 25.9 ohms, R13;
- One shunt, 11.1 ohms, R14;
- Three multipliers (with meter), 1,000, 2,000, 7,500 ohms, R15, R16, R17;
- One metallized resistor, 1,600 ohms, R18;
- One condenser, .5-mf., C1;
- One condenser, .02-mf., C2;
- Thirty-two pin jacks, J;
- Six closed jack switches, JS;
- One open jack switch, JS0;
- One rotary 3-position, 3 pie switch, SW.1;
- One universal 4-, 5-, and 6-prong socket V1;
- One 7-prong socket, V2;
- One 4-pin adapter;
- One 5-pin adapter;
- One 7-pin adapter;
- One six-foot 8-wire cable;
- Two test probe connectors;
- Two 15-inch connectors;
- One control-grid clip connector;
- One control-grid lug;
- One engraved panel, 10½x6½ inches;
- One resistor-mounting panel;
- One analyzing plug;
- Two control knobs for R1 and SW.1;
- Three 1.5-volt batteries;

(Continued on page 502)

Write for this VALUABLE BOOK TO-DAY! It is FREE!

Contains thousands of Listings from a Log or screw to a 100 Watt Dual-Channel Rack and Panel Amplifier

FREE

29.50

7 1/2 WATTS!

CONSUMES ONLY 7 1/2 AMPERES.. CAN BE USED WHEREVER A.C. IS NOT AVAILABLE TUBES REQUIRED 1-237, 2-42

THREE TUBE SIX-VOLT-STORAGE BATTERY OPERATED SOUND TRUCK or AUTOMOBILE AMPLIFIER

COAST-TO-COAST-RADIO-CORP.
123 R-WEST 17TH STREET... NEW YORK, N.Y.

REAL BARGAINS

that will save you money

ZENITH ZE-7 Packs Complete.....\$4.25

3 Stage 250 Push-Pull Power Amplifier. Delivers 14 Watts. Excellent for modulation. Unit. Uses 1-58, 1-56, 2-250 and 2-281. Gain 58 db. Built-in volume control. Will handle 5 large dynamic speakers for PA work. Weighs 32 lbs. (unpacked). Special With Tubes.....\$27.75

\$19.75

STROMBERG-CARLSON No. 3A Phonograph Pick-up

Complete with built-in volume control. 50 ft. of connecting cord, special impedance matching transformer, and bakelite plug. Brand new in original cartons. OUR SPECIAL PRICE.....

\$5.95

HANG-UP CONDENSERS

Wax dipped. Use these high grade units for all power pack replacements. Every one tested at double the working voltage.

Working Voltage	.5 Mfd.	1 Mfd.
400	12c. 12 for \$1.00	15c. 8 for \$1.00
500	15c. 9 for \$1.00	18c. 6 for \$1.00
1000	23c. 5 for \$1.00	29c. 6 for \$1.40

2 Mfd.

400	22c. 5 for \$1.00
600	26c. 5 for \$1.20
1000	33c. 5 for \$1.65

POLYMET Wire-wound strip resistors.
Most sizes from 1 to 2,250 ohms. 8c each. Ten for 55c.

Midset 5 Tube half-wave power transformer. \$1.20.

Universal 110, 220 volt, 25 to 60 cycle power transformer for 8 tube set using 245's or 247's. Special \$2.75.

A Big Special! Compact metal case containing three 1 mfd. and one 2 mfd. units. All 1000 volt DC Working! Case is common ground connection. \$1.45. Four for \$4.95.

Six 25 mfd. 500 Volt bypass units in metal case \$2.54. Case is common ground

Royal Short Wave Receivers With "Trans-X" Coupling

"The set that really works"

SEND FOR CATALOG

connections. At least one is needed in every set. 43c each. Ten for \$4.95. Same, but with six 1 mfd. 35c each. Twelve for \$4.10.

Dry electrolytic condensers, 500 Volt peak, 8 mfd. 40c each. Six for \$2.20 4 mfd. 35c each.

An excellent high inductance choke to provide maximum filtering in any power buck. Consists of a 20 Henry 100 Mil and a 30 Henry, 125 Mil choke in a silver finished metal case. In parallel will handle 200 MA and still have high inductance. No choke as good as this one has ever been offered at this low price.

2 Lbs.....\$1.45

REAL WHOLESALE PRICES on everything in radio

Western Electric

M4C 100 ft. three conductor nickel cables. Shielded. Heavy rubber covered for outdoor use. List \$32.00. Special \$37.75.

Three wire 6 ft. cords.....15c

Three conductor shielded microphone cords. Brown braid covered.

8 ft.....\$0.50 12 ft.....\$1.00

25 ft.....\$2.00 50 ft.....\$3.00

BRISTOL unaged microphone transformers. For single or double button 200 ohm mikes. Very special. 95c.

RANGAMO P. P. input transformers. \$1.25

Fixed men condensers. Moulded bakelite.

All sizes up to .002. 10c each. 15 for \$1.00

Constant RCA RPA Pack Parts. Transformer \$4.75. Audio 45c. 11 output 50c.

7 mfd. condensers 95c. Resistors 45c.

Boech 29, 425 Pack Parts. Transformer \$4.50. Condenser Block \$2.25. Audio \$1.25. Resistors 30c.

All prices F. O. B. New York and subject to change. Deposit Required

HARRISON RADIO CO. Dept. R-2
142 Liberty St. **New York City**

UNIVERSAL

3-PIECE ADJUSTABLE COMBINATION STAND

This full utility, all-purpose, adjustable banquet and floor stand outsells any stand on the market—three telescoping sections—collapsible for easy transportation—can be extended to full standing height—honest, solid construction—shapely finished in highly polished nickel plate—lowest price in history—only \$10.00 list, including 8 suspension springs.

Universal Microphone Co., Ltd.
424 Warren Lane, Inglewood, Calif., U.S.A.

Only TRUVOLTS

Have These Advantages

- 1—Patented construction permits air-cooling, larger wire, greater radiation and longer life.
- 2—Spiral winding permits better electrical contact.
- 3—Sliding clips permit accurate adjustment. 1,000 volt insulation.
- 4—Full-length fibre guard prevents injury from contact with tools and hands.

Write Dept. RC-2 for Complete Catalog
175 Varick St., New York, N.Y.

ELECTRAD

INC.

RADIO-CRAFT for FEBRUARY, 1933

501

www.americanradiohistory.com

DEALERS and Servicemen!

Buy hi-test

REPLACEMENT PARTS
Direct from the Manufacturer
AND SAVE 50%
POWER TRANSFORMERS

Cat. No.	Models	Price
1218	Atwater Kent 37.....	\$1.95
1018	Victor R32, etc.....	1.25
1001	RCA 17, 18, 33.....	1.70
	Philco, all models.....	2.45

FILTER CONDENSER BLOCKS

Cat. No.	Models	Price
1474	Atwater Kent 37.....	\$1.55
1471	Majestic, 70 series.....	1.65
1472	Majestic, 90 series.....	1.65
1473	Majestic, 180.....	1.95
1470	Victor, all models.....	.85
1461	RCA 18, 33, 51.....	.35

POWER PACKS

Cat. No.	Models	Price
1050	Atwater Kent, 10, 42, 44.....	\$3.85
1052	Atwater Kent 46, 47, 52.....	5.50
1169	Steinert 261, 262.....	6.95
	Kolster, all Models.....	9.85
1292	U. S. Radio & Tele for '26, '27 and '21 sets.....	6.95

BY-PASS CONDENSERS

Cat. No.	Models & Cap.	Price
1243	Crosley 1/2 Mfd. No. 4919.....	\$.17
	Spartan .25, .5 and 1.....	.28
	RCA, all models.....	.10
	Atwater Kent, all models.....	.12

CARBON PIGTAIL RESISTORS

1350	Kit of 50 assorted.....	\$.95
1351	Kit of 100 assorted.....	1.85

SEND FOR YOUR COPY
OF THIS PAPER



BALTIMORE RADIO CORP.
Dept. C
725 Broadway New York, N. Y.

MIDGETS

Mr. Serviceman and Dealer

Midgets of High Quality

4 Tube 2 Circuit with tubes.....	\$11.00
5 Tube 3 Circuit with tubes.....	13.00
5 Tube Super with tubes.....	15.50
110 Volt, 60 Cycle, A.C.	
5 Tube Auto-Radio with tubes.....	\$16.00
(No Batteries Included)	
Regular 90 day guarantee including tubes	

TRUMAN RADIO SHOP

7443-C Stewart Ave. Chicago, Ill.

THE INTERNATIONAL "KADETTE"

(Continued from page 465)

States where 220 volt circuits are used. However, in some foreign countries and on ships, this service is used extensively. To permit the set to be used on any current supply, the manufacturer has made a high voltage adapter that is inserted into the socket in place of the usual power plug of the set. The latter plug is then inserted into the adapter.

This adapter reduces the 220-volt supply, either A.C. or D.C., to the 110 volts required by the receiver. The manufacturer also makes an interference eliminator that may be purchased separately for use in districts bothered a great deal by man-made static. This is especially prevalent in D.C. districts, and hotels or office buildings with their own direct-current generators.

The installation of the set is quite simple. Merely insert the power plug into the socket, stretch the 20-foot aerial wire supplied with the set around the room, or drop it out of the window, and turn the switch on. On the left of the panel is the volume control, and to the right of the speaker grille is the tuning knob. The tuning is quite sharp—sufficient to separate the local stations in the heart of Manhattan. The volume is sufficient to fill a medium size room on all the local stations. DX response, too, is satisfactory.

The manufacturer of this set has incorporated a servicing policy with these sets that is worth mention. On the container in which the set is shipped, a tag is pasted. On the tag is an explanation of the service policy. Any set returned within a year of the time of purchase will be repaired by returning the set in the original carton with a dollar bill. The vacuum tubes are guaranteed for 90 days and a charge is made for replacements after that date. The cabinet is not included in the service guarantee. A charge of \$2.50 is made for a new cabinet, in case of breakage.

The manufacturer thus assumes the responsibility for servicing the sets. This policy has made it possible for them to sell the sets through thousands of stores and dealers who would not otherwise carry them, due to lack of service facilities.

Of interest to the dealer and Service Man, however, is the new policy of the company in which they state that they will show how a worthwhile profit can be made on the \$1.00 service charge. In this way, they expect to contact service organizations in every city, for the purpose of repairing the sets.

SUPREME "56"

(Continued from page 501)

One battery container;
One spring for battery;
One fuse block;
Four panel brackets;
Eight rubber bumpers;
One carrying case;
Bolts, nuts, screws, wire, etc.

SUPRA-CONDUCTION

● AT a recent meeting of the British Association, the question of conduction of metals at very low temperatures was discussed. The results vindicated to some extent the classical experiments of Dewar and Fleming who, in 1833, declared that at absolute zero the resistance of metals would decrease to zero. (Absolute, or Kelvin, it will be recalled, is nothing but the Fahrenheit scale starting at actual zero. For a more detailed discussion of temperature, the reader is referred to page 1130 of the November, 1932 issue of EVERYDAY SCIENCE AND MECHANICS.)

The actual results, however, showed that certain metals had an apparent zero resistance at temperatures slightly above absolute zero, i.e., at about 3 degrees Kelvin, or absolute (456 degrees below zero, F.).

The metals were tested by immersing them in liquid hydrogen or helium and starting a circulating current. It was found that 1,000 amperes could be maintained through wires of relatively small cross section and the current circulated for over thirteen hours with no external force, i.e., of its own accord.

CLASSIFIED ADVERTISEMENTS

Advertisements in this section are inserted at the cost of ten cents per word for each insertion—name, initials and address each count as one word. Cash should accompany all classified advertisements unless placed by a recognized advertising agency. No less than ten words are accepted. Advertising for the March, 1933 issue should be received not later than January 9th.

CHEMISTRY

BECOME A TRAINED CHEMIST. Thousands of opportunities—fascinating career. Learn at home. Complete experimental laboratory outfit given. Write for big free book. Chemical Institute, 19 Park Place, Dept. RC, New York.

DOGS

BEAUTIFUL Registered bull pups, \$15. Bull-dogs. 501-RC, Rockwood, Dallas, Texas.

INVENTORS

PATENTS—SMALL IDEAS may have large commercial possibilities. Write immediately for free book, "How to Obtain a Patent" and "Record of Invention" form. Delays are dangerous in patent matters. Free information on how to proceed. Clarence A. O'Brien, 533-A Adams Building, Washington, D. C.

PATENT ATTORNEYS

PATENT YOUR INVENTION: Send for FREE book, "How to Obtain a Patent," and "Record of Invention" blank. Ask us about how to protect your ideas. Deferred payment. Victor J. Evans Co., 620 BB Victor Bldg., Washington, D. C.

RADIO

SENSATIONAL Microphone Value—Universal Model "Y"—Experimenters' single-button, watch model type. 200 ohms. Pure Gold Spot Center Diaphragm. Only \$2.00, including valuable 1933 general catalog with diagrams. Universal Microphone Co., Ltd., Inglewood, Calif.

TRANSFORMERS REWOUND, varnished, baked, guaranteed, reasonable cost. **SPEAKER REPAIRING,** magnetic \$2.00-\$2.50; dynamic, voice coils, fields, etc., reasonable charges. Clark Bros. Radio Co., Albia, Iowa.

RADIO Service Men Attention—Power transformers, rewind or rebuilt, to your requirements. Meyke Radio Service, 2624 Margaretta, Maplewood, Mo.

RADIO Service Men: A guaranteed sure fire business getter! Send two dimes for complete details. Radio Service Laboratory, Wooster, Ohio.

GUARANTEED "Pocket Radio," \$2.00. Catalog, 10c. Neil Tasker, Shamokin, Pa.

DAYRAD 175 Oscillator—Newest model, complete \$18.00. Arthur Maybaum, 6718 21st Avenue, Brooklyn, N. Y.

MAGNETIC Speakers adjusted, coils rewound, \$1.25. Radio Service, Flora, Indiana.

SHORT-WAVE SETS. Kits, supplies, wholesale Catalog 5c. Federal Radio & Telegraph Co., 4220 E. Clifford Road, Cincinnati, Ohio.

FOR SALE, National Kinematic Remote tuning controls. Brand new. Anthony Kaye, 2441 32nd Street, Astoria, New York.

FREE CATALOG

Hams—Servicemen—Dealers

Our new catalog is replete with bargain values.
SEND FOR IT TODAY.

TRY-MO RADIO Co. Inc. 85A Cortlandt St.
New York City

Sensitivity **SHURE** *Tone Quality*
MICROPHONES
TRADE MARK REGISTERED
SHURE BROTHERS COMPANY
Manufacturers-Exporters
S. M. SHURE, Inc.
337 WEST MADISON ST. CHICAGO, ILLINOIS

The ONLY WORLD-WIDE Radio Magazine!



European radio publications are abounding with new circuits and new radio developments that have found their way slowly over to the United States. The reason is since there is such a tremendous amount of original radio engineering going on in this country, there has been no publication that catered to the foreign developments. All the American radio publications must report the American activities first and, as a rule, have no room left for what is going on in Europe.

Mr. Hugo Gornsbach conceived the idea of bringing to American readers a totally different radio publication, the like of which has never been published before; and the result is RADIO REVIEW AND TELEVISION NEWS.

This is not entirely a new magazine; it is, really, two magazines in one. A section devoted to television has been retained, which will report in every issue, the major American and European television advances; but the big, front section is given over to an international radio digest. This magazine, therefore, will perform the function that, for instance, the LITERARY DIGEST is serving in literature. You may not be aware of the fact that there are some 160 radio publications printed outside of the United States; but from all of these publications RADIO REVIEW is extracting the best—the Radio Meat—which you want.

RADIO REVIEW AND TELEVISION NEWS shows you a true perspective of what is going on in radio all over the world. It gives you hundreds of new radio hook-ups, special circuits, now time-saving kinks, new money-making ideas galore. You will find here the latest radio circuits and sets from France, Germany, England, Italy, Russia, Norway and even Japan.

Dozens of translators have been busy to make each issue of the new combination magazine a memorable one.

Features of the Current Issue:

- Build Your Own "Theremin"—Electric Musical Instrument
- A Band Pass Filter to Improve Receiver Selectivity
- Complete Crystal Receiver in a Tobacco Can
- Modern Tuning Coil Practice
- Hints on Tone Correction
- The Screen Grid Tube as a Detector
- Matching the Load
- Notes on Gang Tuning
- The "Volume" Speaker
- Radio Kinks
- Review of American Radio Magazines
- Digest of Radio Patents
- Also: enlarged television section containing numerous circuits and operating hints.

Clip and Mail Coupon Today!

RADIO REVIEW AND TELEVISION NEWS
98 Park Place, New York City (Mark X in Square Which Offer You Desire)

Gentlemen:

- As per your special offer, I enclose \$1.25 (Canada and Foreign \$1.50) for which enter my subscription to RADIO REVIEW AND TELEVISION NEWS for one year.
- Send me the current issue of RADIO REVIEW AND TELEVISION NEWS, for which I enclose 25¢ (U. S. stamps or coin accepted) with the full understanding that if I do not like the magazine you will refund the money.

Name
Address
City and State

AMPLITENNA

(Continued from page 460)

Power Pack Shielding

It is advisable to shield the entire power system from the amplifier section, but time did not permit this refinement. (The constructor should not find it difficult to arrange such screening.) In lieu of this shielding, the authors made provisions in the choice of equipment and in the placement of the parts which compensated for this, within practical limits (the background noise is observable only when resistor R1 is adjusted for maximum volume, with the amplitenna connected to a very sensitive broadcast receiver).

For instance, the cans of the three filter condensers tend to act as shields between the power units and the R.F. amplifier, particularly the "antenna" Akaformer. Note that while this device is connected in the output circuit of the last R.F. pentode, and thus has no tendency to transfer any interference pick-up to any section of the amplitenna where it might be amplified, still, this Akaformer is connected, via the R.F. transmission line, to the input circuit of the broadcast receiver where such parasitic currents are subject to amplification to a degree dependent only upon the sensitivity adjustment of the broadcast set. It is interesting to check this particular point by removing V3 from its socket, "floating" the shield-can of V4, and noting the noise-level which is then only a function of the sensitivity of the broadcast set.

Since transformer P.T. is not equipped with a static shield for preventing lower-line interference due to lights being turned on or off (either may cause a click), or the operation of other types of circuit breakers, and thus backing into the amplifier via the power pack, it may be necessary, in electrically noisy locations, to use a light-line filter made by shunting across the power line two 0.1-mf. condensers, the center-tap of which is grounded. The curve A in Fig. 6 shows (in a general way) the degree in which "line noise" may be expected to travel along the power lines, depending upon the frequency of the interference. (This curve appeared in the December, 1932 issue of Electronics.)

The R.F. Transmission Line

Merely to connect the output of the amplitenna power antenna, by means of a single lead, from the coupling condenser C5 to the "Ant." post of the broadcast antenna would be "fine business," if it were not for the fact that local reception conditions may not permit this procedure. That is, local broadcast stations, or local static-generating equipment may render the idea impracticable. Merely using an R.F. transmission line between the amplitenna and the set would solve the first problem, but the second is another story.

In the first place, the source of interference may be power lines in the walls of the room. To check this possibility we make the whole apparatus a modified interference locator by removing the little "lead-in" which connects to the antenna-plate, from the "Ant." post on the shield-case of the amplitenna, and connecting this short wire to the "Gnd." post, instead. Then, a long wire, rubber-covered, is connected to the "Ant." post of the amplitenna which is then connected to the broadcast set and the whole assembly put in operation. Now, by moving the "exploring" wire to various points in the room, or to points outside, it is only a matter of a few moments until the noise source has been tracked to its lair. This is all very fine for simple cases of interference, but in many instances a better design of "exploring" wire will be required. In such cases a fine plan is to use a second R.F. transmission line. The "exploring" end of the line terminates in the "antenna" Akaformer; a "set" Akaformer connects the other end to the input posts on the amplitenna, thus affording an ideal arrangement.

The advantage of being able to confine the signal pick-up to a particular location, even a short distance from an interference source, by moving the amplitenna to the position of most noise-free reception, is clearly indicated in the family of curves, in Fig. 6, (reproduced from the article, "Reducing Man-Made Static," by Glenn H. Browning, in the December, 1932 issue of Electronics).

Satisfying the Landlord

If the building is highly shielded, and located
(Continued on page 505)

GET THE

new



free

50c

—Yours for the Asking!

A gold mine of information . . . It's a "Wow" for replacements . . . for a fistful of Centralab Volume Controls are enough to service practically any known make. Priced regularly at 50c . . . it is yours for the asking.

Enclose two 3c stamps to cover postage and wrapping and get this 50c GUIDE FREE. Write on your own or your firm's stationery

Centralab

CENTRAL RADIO LABORATORIES
930 E. Keefe Ave. Milwaukee, Wis.

BACK ISSUES of RADIO-CRAFT can be had at the price of 25c each. Address RADIO-CRAFT, 98 Park Place, New York City.

SHALLCROSS

No. 651



RADIO SET TESTER

For 4-, 5-, 6- and 7-prong tubes

This new circuit makes it possible for the service man to construct a light-weight and compact, up-to-date, radio-set tester for all tubes and radio sets in general use. It uses a special set of Shallcross Super Akra-Olhu Wire-Wound Resistors.

Send 6c in stamps for Bulletin 161-P containing wiring diagram, construction details, and operating chart.

Shallcross Mfg. Company

ELECTRICAL SPECIALTIES
700 PARKER AVENUE
Collingdale, Pa.

QUASI-OPTICAL HOME EXPERIMENTS

John B. Brennan, Jr.

LET us review briefly what the three previous experiments in this department have shown us so that we may have a clear idea of exactly where these experiments will ultimately lead us. First, there was outlined, rather sketchily, the numerous experiments which will be treated monthly in this department and also a simple experiment was described illustrating the property of a certain unit, called the photoelectric cell, to transform variations of light into variations of electrical current. Then a simple photo-electric cell amplifier was described so that its construction could be duplicated, and, finally, a high-grade audio amplifier with a neon tube output circuit was described for the purpose of amplifying electrical currents and transforming them into light variations. In this neon output tube, what appears to be a pinkish glow of constant brilliancy is actually a series of rapid fluctuations of light, each fluctuation conforming to the fluctuation which passed through the amplifier. We might readily term this an electrical means of obtaining a modulated light source.

Several mechanical means for obtaining a modulated light source with which to operate a photoelectric cell can easily be constructed by the experimenter with material usually in his possession. They are described here, together with a means for condensing and magnifying a given light source and focusing it upon the "gate" of the mechanical modulator.

Probably all of you are familiar with the childhood experiment of using a magnifying lens to catch the sun's rays and focus them on the back of your hand in a small, intensely brilliant spot of light which, in a short while, feels quite hot. Well, this same process can be repeated with an inexpensive lens of the type usually obtainable in the "five and ten" store. But, before going further, let's look at the accompanying sketch. We see that first, at the left, there is a light source which we shall call the exciter lamp;

then there is the lens; next the gate; then the mechanical modulator and, finally, at the right, the photo cell with its attendant amplifier. Now let's see what happens. Suppose that to the mechanical modulator there is connected some unit which will drive it at an audio-frequency rate. Then, the light which comes from the exciter lamp is magnified and confined or focused onto the gate. This constant source of now intensified light is then modulated at an audio-frequency rate by the mechanical modulator and impinges on the active area of the photo-electric tube. This tube changes these minute and relatively weak variations of light into variations of electrical current and the amplifier builds up this fluctuating current to a point where it is of

sufficient power to operate a loudspeaker.

Experiments can be conducted in the construction of two types of mechanical modulators: one employing the "innards" of a magnetic type loudspeaker, the other the electro-magnet and moving coil of a dynamic speaker.

Suppose that in front of the "gate," which may be nothing more than a square hole or slot made in a piece of metal, we place the pin which is connected to the armature of the magnetic-type loudspeaker unit. The placement should be such that in a state of rest the pin completely covers the hole so as to exclude all light from the lens. Now, if the speaker unit be energized with audio-frequency currents say, from a radio set, then a piston-like motion will be imparted to the pin and, in moving up and down, at an audio frequency rate, it will move away from its original position and so admit light through the gate.

The same piston-like motion, probably of a more defined and forceful character can be obtained with the aid of a dynamic speaker unit from which the cone (but not the centralizing spider) has been removed and a piston affair attached. Here, because of the greater action obtained, the gate can be made relatively large, admitting considerable light but not requiring so great an amplifying function on the part of the photo-cell amplifier.

Incidentally, these experiments were originally tried, on the part of the writer, in an attempt to record, on 16 mm. film, an intelligible sound track. Of course, with 50 foot rolls of 16 mm. film selling at present prices this is undoubtedly an expensive experiment and is only recommended to those whose pocketbook can stand the strain of spoilage.

For details concerning the construction of the "gates" with their pistons see the accompanying sketches.

Next month: bending light through a quartz tube.

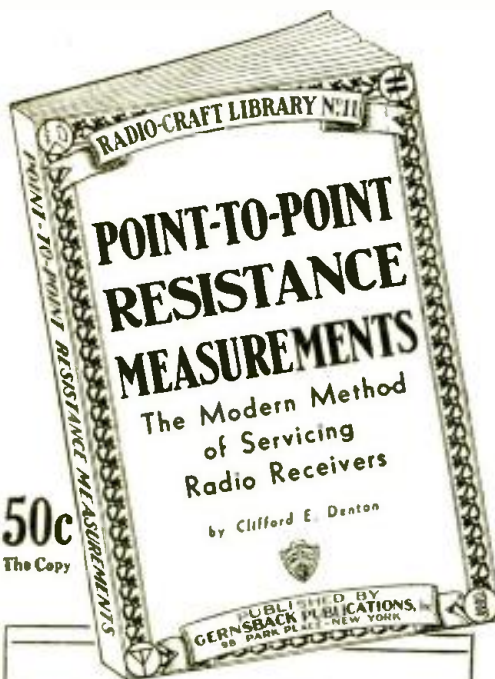
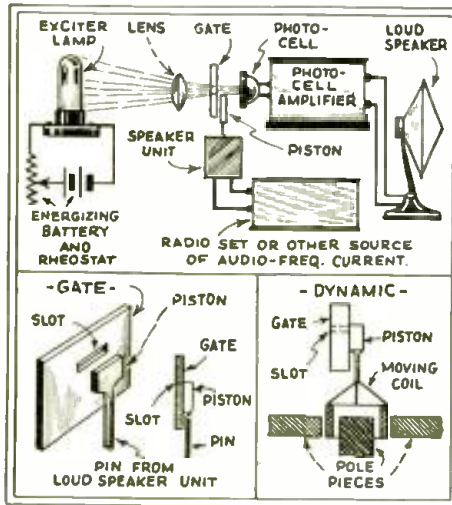

"Cliff" Denton has written Point-to-Point Resistance Measurements

The Modern Method of Servicing Radio Receivers

—ANOTHER VALUABLE BOOK FOR SERVICE MEN

Of the difficult problems which Service Men face today when repairing receivers, the greatest is that of replacing proper resistance values in sets. This task becomes even more difficult when the values of resistors are unknown; and manufacturers of many standard sets do not pass this information on to Service Men.

In this new book, "RESISTANCE MEASUREMENTS," radio men will find the information needed to quickly place a receiver in normal operating condition. This book cuts in half, the time usually required to adjust the average set.

Sufficient space has been devoted to the elementary problems and the theory of electricity as it is applied to resistance measurements so that the Service Man will have a comprehensive idea as to how to overcome this problem.

Below you will find a partial list of the contents which will appear in this new book . . . prepared by one of radio's foremost service writers, Clifford E. Denton.

Partial Contents of POINT-TO-POINT RESISTANCE MEASUREMENTS

- CHAPTER 1—INTRODUCTION. Advantages of Resistance Measurement Method of Servicing for Radio Work.
- CHAPTER 2—Basic Principles.
- CHAPTER 3—Methods of Resistance Measurement.
- CHAPTER 4—Resistors in Radio Receivers and Amplifiers.
- CHAPTER 5—Point to Point Resistance Measurements in Typical Radio Set using Ohmmeter.
- CHAPTER 6—Resistance Measurements using Modern Tester.
- CHAPTER 7—Routine Testing where Circuit Diagram is Available and where Resistances are Known.
- CHAPTER 8—Routine Testing where Circuit Diagram is Not Available and where Resistances are Unknown.
- CHAPTER 9—The Relation of Voltage Testing Methods to Resistance Measurement.
- CHAPTER 10—APPENDIX. Resistance Charts, etc.

64 PAGES — OVER 100 ILLUSTRATIONS
6x9 INCHES

THIS BOOK IS A NEW ADDITION TO THE RADIO-CRAFT LIBRARY SERIES

Name

Address

City State

GERNSBACK PUBLICATIONS, Inc. RC-233
96-98 Park Place, New York, N. Y.

Enclosed you will find my remittance of Fifty Cents (check, stamps or money order accepted), for which you are to send me One Copy of POINT-TO-POINT RESISTANCE MEASUREMENTS, by Denton.

50c
The Copy

3 New 50c Books



No. 1.
FORMULAS AND RECIPES
For the Practical Man
By S. GERNSBACK

An extremely helpful book showing you how to save money by making in your own home, at a fraction of the regular cost, the hundred and one preparations which you now buy for use at home or business.

PARTIAL CONTENTS:

1. Adhesives; Glues; Cements. 2. Cleansing: Stain Removers, Bleaches. 3. Metal Craft: Coloring, Oxidizing, Plating, Polishes. 4. Paints: Colors, Stains, Varnishes. 5. Glass-Working: Cutting, Drilling, Boring, Etching, Engraving. 6. Wood-Craft: Fireproofing, Acid-proofing, Waterproofing, Furniture Polishes. 7. Inks: Sympathetic, Invisible, Hectograph. 8. Photography: Developers, Emulsions, Fixers. 9. Antidotes for Poisons, Remedies for Burns and Scalds, Disinfectants. 10. Preparation, Manipulation, Handling, Mixing, Tables of Weights and Measures. Useful Tables.

No. 2. **FUNDAMENTAL PRINCIPLES OF RADIO**
Radio Simply Explained—Its Origin, Nature and Functions
By LOUIS MARTIN



Prepared with special consideration given to young members in the radio profession, and those who have gained their experience in a haphazard fashion. This radio primer is a handy fundamental aid for "checking up" and systematizing your knowledge of radio. Regardless of how much you know about the subject, you should read this book.

PARTIAL CONTENTS:

Chapter I—Fundamentals of Radio: Electricity, Resistance, Batteries, The Magnetic Circuit, The Magnetic Field, Inductance, Condensers, A.C. Circuits, Propagation of Radio Waves; Chapter II—The Simple Radio Set, Single, Two, and Three-Circuit Tuners, The Battery Set, Vacuum Tubes, Electric Sets, Loud Speakers; Chapter III—Diagrams, How to Read Them; Chapter IV—Amateurs and Broadcast Stations, Talking Pictures, Television.

No. 3. **ELEMENTARY MATHEMATICS**
for the Technician and Craftsman
By C. SHAINMARK

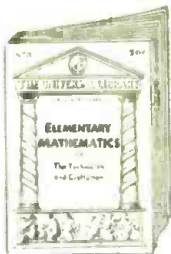

This manual has been especially prepared for the man who wishes to acquire a working knowledge of the elementary principles of mathematics. A complete treatment of the subject is given by the author, Mr. C. Shainmark, with special attention to the use of mathematics in Radio and other technical work for those who employ its formulas daily.

PARTIAL CONTENTS:

I—Arithmetic: Addition, Multiplication, Subtraction, Division, How to Use Decimals; II—Fractions, Percentages, Ratio and Proportions; III—Powers and Roots; IV—The Metric System; V—How to Measure Surfaces and Volumes; VI—Mathematics for the Manual and Technical Craftsman; VII—Special Mathematics for the Radio Technician; VIII—Commercial Calculations, Short-cut Arithmetic, Interest Calculations, Discounts; IX—Weights and Measures; X—Useful Tables.

All our books are of uniform size, 6 x 9 inches, and contain 64 pages. The books are printed on strong paper with stiff colored covers.

PRESS GUILD INC., 16 Murray St., New York N. Y.
Enclosed find \$..... for which mail me postpaid the following books:
No. 1 No. 2 No. 3
50c each, Postpaid.

Name
Address
City and State

AMPLITENNA

(Continued from page 503)

where reception conditions are poor, it may be necessary to use an outdoor antenna, to which the amplitenna, located near the broadcast receiver, may be connected by means of a second R.F. transmission line. However, some apartment house owners declare "thumbs down" to outdoor wires, and here is where the amplitenna may be used to "put one over." Just weather-proof the instrument, and suspend it outside a window, just like a ledge flower-box. The amplitenna used in this particular manner, in a good location, will operate up to about 25 sets, if desired.

Connecting the R.F. Transmission Line

The "antenna" Akaformer of the "lead-in" used to connect the amplitenna to the radio set is shown in close-up in Fig. C. The shielding must be pushed back about 1/2-in. from the lead connected to the center post and anchored to the G post; the center post is one terminal of the shielded lead. The other end of the shielded lead connects to the "set" Akaformer at the post marked "Ant."; the shielding is grounded underneath the head of the screw lettered "Shd." Connect a good ground to post "Gnd." The "G" lead, black, connects to the "Gnd." post of the broadcast set; either lead A1 or A2, both of which are red, connects to the "Ant." post of the set. In each instance tried by the writers, the A2 lead gave the best results. Lead A1 is for high-impedance matching and lead A2 for low-impedance matching.

Multiple-Receiver Antenna System

The same general idea of connections is followed where a second R. F. transmission line may be used to connect a remote outdoor antenna to the amplitenna for multiple-receiver systems. Several hundred radio sets may thus be operated from one antenna, without interaction or interference between them.

The second "antenna" Akaformer, part No. A-502, for this service, connects to the outside aerial as shown in Fig. 3. The second "set" unit, No. A-503, connects to the input binding posts on the amplitenna; the antenna-plate of the amplitenna is then connected to the ground post on the amplitenna.

Operation of the shielded lead-in under those conditions is shown in graphic form in Fig. 5, which is reproduced from the article, "Reducing Man-Made Static," by Glenn H. Browning, in the January, 1933 issue of RADIO-CRAFT.

An interesting and valuable feature of the amplitenna—broadcast receiver combination, which the writers observed during the period of testing, was considerably increased selectivity in the operation of the broadcast receiver, despite the fact that the signal strength of stations had been increased many times! The suggestion has been advanced that since it was necessary to vary the screen-grid potential of the broadcast set, for a given volume, the input and output impedances were greatly increased. Since these factors represent a resistance in shunt to the tuned circuits, increasing their value tends to reduce the effective series resistance and thus the selectivity of the tuned circuits increases.

Car-Radio Antenna-Plate

A somewhat similar idea to that of the regular amplitenna as originally designed is found in the field of automotive radio, where the amplitenna is placed in the most satisfactory position on the car (ordinarily, on top of the running board), and then the amplified signal carried back to the car radio set by means of the shielded R.F. transmission line. Bosch for instance, uses a simple plate-type antenna and an R.F. transmission line, which is quite all right where the set has adequate sensitivity.

In the November, 1929 issue of RADIO-CRAFT there appeared the article, "Building a 1930 Electric Set," by Clyde J. Fitch. The feature of this set design was the use of an untuned, multi-stage R.F. amplifier preceded by a band-selector. (Incidentally, the original set is still in operation and giving a very good account of itself.) Applying the same idea to the amplitenna it is seen that merely by preceding the unit with a band-selector, and connecting the output to a detector and A.F. section, in a complete receiver is available. The only tubes required for such an arrangement are those needed for the detector and A.F. circuits, and the sepa-

(Continued on following page)

TRAIN WITH RTA TO BE A



It's vital that you become a Radio technician through R. T. A. teaching NOW! New, complicated circuits... new tubes... the approach of popular television... all require professional service men. Their future is secure—their opportunities to make good money are unlimited. And R. T. A. can place you in their ranks quickly—easily—and surely through interesting home study that's understood by anyone who can read English.

SET ANALYZER— AT NO EXTRA COST

Included with R. T. A. Training is this excellent set analyzer and trouble shooter. After a few lessons you will know how to use it, and it becomes an immediate means of earning as you learn. Many R. T. A. students make far more than enough to pay for their training by spare time service work, using this analyzer. In addition, R. T. A. gives you life membership in a great radio service men's association with the privilege of consultation on "tough" problems at any time, and an employment service that works to keep you at work.

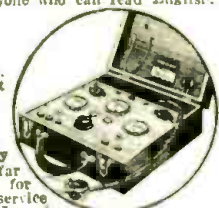

WONDERFUL OPPORTUNITIES NOW!

You don't have to wait for a dim and distant future as an R. T. A. professional Radio Technician. Even though there was never another receiver built—even though all the tremendous progress in this gigantic industry stopped—there would be enough work in conditioning and reconditioning the sets now in operation to assure you a good living. Look into this great field of professional radio service work. Learn, too, of the many other glowing opportunities open to true Radio technicians in this field. Fill out and mail the coupon—it will bring you FACTS that will surprise you—and that may open up for you a permanent way out of depression and job-fear.

FILL IN ~MAIL TODAY

RADIO TRAINING ASS'N. OF AMERICA,
Dep't. RCA-2, 4513 Ravenswood Ave., Chicago, Ill.
Send me the FACTS about R. T. A. professional training, together with information about the opportunities in the radio service field, without obligation to me.
NAME.....
ADDRESS.....

Sprayberry's RADIO DATA SHEETS

Act at once—start making more extra profits now!

F. L. Sprayberry has inaugurated a unique DATA SHEET service for Radio Service Men. Each month SPRAYBERRY DATA SHEETS are mailed out to thousands of Radio Service Men all over the United States and Canada.

These Data Sheets tell in concrete words how to rewire old, obsolete receivers for new, modern tubes and circuits. For instance, instructions are given for rewiring the Majestic 70 series for '58, '57, '56 and '45 tubes. Other older receivers will be covered in a like manner. Actual wiring directions are given with diagrams. Thus Mr. Sprayberry has opened up a vast source of profit for the service man—a source where no profit is being made at present.

This unique service assures the Service Man a steady income each month. The cost is trifling—less than thirty-five cents a month.

PLANS FOR REWIRING ANY SET ANALYZER OR TUBE CHECKER ARE ALSO AVAILABLE FOR \$1.

Send for a complete FREE list of subjects to be covered in this Data Sheet Service.
F. L. SPRAYBERRY
132 BRYANT STREET, N. W., WASHINGTON, D. C.

Get Started In Radio

Resident courses in

RADIO SERVICING RADIO OPERATING

Practical instruction on different types of circuits including testing with analyzer, ohmmeter and oscillator. Material supplied. Prepares for government and service examinations. Write for booklet "Opportunities in Radio"

Educational Department
WEST SIDE Y M C A
7 West 63rd Street, New York

DEMAND FLECHTHEIM

SUPERIOR DRY
ELECTROLYTIC
CONDENSERS

Because They are the Best

A. M. FLECHTHEIM & CO. INC.
136 Liberty St. N.Y. U. S. A.

RADIO SERVICE MEN

Be sure to read the announcement on Page 497 of this issue which tells about the new ORSMA BULLETIN. It is the most up-to-the-minute news tabloid for all radio Service Men.

(Continued from preceding page)

rate power system which they would require. Perhaps some ambitious technician may want to try out this idea. Incidentally, Sparton sets, using tubes of early design, were made this way, (the new, high-mu type 58 tubes only recently became available.)

Miscellaneous Data

To increase the convenience of operating the amplitenna there is provided an off-on current-control switch, Sw., which operates both the broadcast set and the amplitenna. This switch is in the circuit of one of two twin-conductor leads; one end terminates in a fused plug MP which plugs into the power line and the other connects to the primary terminals on the power transformer. To these also are connected one end of the second twin-conductor lead; the other end terminates in a receptacle FP for the line-plug of the broadcast set.

Correct operating potentials for the tubes are obtained by adjusting tap A on voltage divider R6 until a meter, connected from plate to cathode, indicates a potential of 250 volts, with resistor R1 adjusted to the extreme right, or full-volume position. Then, tap B is varied until the screen-grid potential is about 100 V., after which both taps are tightened permanently and the entire divider is taped to insulate it from all possible contact with other conductors. Resistors R1, R2, R3 automatically supply the "C" potential required by each tube.

Better use the fused line-plug specified in the List of Parts—it may save you some money! Fuses in the plate circuits of the 82, at X, would be a safety factor against shorts in this portion of the power pack. Ordinarily, a 2 mf. condenser will be quite sufficient for C8. Be careful to see that all the components are so mounted as to clear the cover-shield when it is put over the metal base-plate.

In a few instances, particularly where the associated broadcast receiver is designed to encompass the police wavelengths, a slight hum may be encountered. (The Duratrans are not intended to be used much beyond the range of 200 to 545 meters.) This is due to the cathode

(Continued on page 508)

First Time in Radio History! 4-TUBE RADIO RECEIVER

Complete With

Cunningham
RADIO TUBES

1-57; 1-58; 1-47; 1-80



Cabinet of beautiful Oriental walnut with two-toned front panels.

The quality of these receivers is of the finest—based on 20 years radio experience. Rola Speakers, Dubilier Condensers, Aerovox Tubulars, Centralab Volume Controls—all these assure you of quality.

Price Complete \$13.50

Dealers write for discounts and exclusive territories.

RADIO CHASSIS, INC.

112-116 West 18th St. New York, N. Y.
(Formerly Marquette Radio, Inc.)

Licensed Under Patents Granted by Radio Corporation of America and The Hazeltine Company, Export Department—1457 Broadway

Presenting

The leader in our fall line of POWER AMPLIFIERS

at the lowest prices in radio history

THE NEW P 50

Including all our new features Plus Mercury Vapor Rectification saves \$10.00 is tube cost by use of the N3 Tube

Tube Equipment 2-258-2, 250-1-R3 Mercury Receiver. Tapped output—9-15 for Voice. Grid input 4000 ohms for A. C. Speakers. For Microphone, Phono and Radio Input. Delivers 12.5 watts undistorted. Price



\$16.95

Write for our new price list and Technical data. Amplifiers from \$9.85 up.

Blair Radio Laboratories

18 Warren Street

New York, N. Y.

Thousands of Radio Men have asked for a book of this kind—

The RADIO-CRAFT INDEX

It contains a thorough, alphabetical and topical arrangement of EVERY article and subject which has been published in all the issues of RADIO-CRAFT from July, 1929 to June, 1932

RADIO Men have conclusively proved to us the need and practicality for a book which has included in it, a comprehensive and complete listing of every article which has thus far been published in RADIO-CRAFT. A book which has each topic so sub-divided and cross-indexed that a mere glance at a subject will give you any number of classifications and uses of it. For example, if you look at tubes, you find under this topic, various sub-titles, general, power, transmitting, photo-cells, testing of tubes, thyratrons, etc. Every article or notice in the book has been considered so deeply important that when you refer to a certain classification, listed below the main topic, you will find perhaps a dozen or more articles treating the subject from different angles. The author

in each case is given—the exact issue in which the article appeared, and on what page it is to be found.

So accurately compiled, by C. W. Palmer, one of radio's foremost writers, that in less than two minutes you can turn to any article—needless to wade through all the issues of RADIO-CRAFT which have been published during the past three years.

The RADIO-CRAFT INDEX is exactly the same size as the monthly magazine. It can be conveniently kept on file with the copies of the magazine—ready for quick reference. The index is printed on good paper with firm flexible covers to protect the inside. This book is sold only by the publishers at 25c the copy. Mail coupon below for your copy of the RADIO-CRAFT INDEX.

Briefly outlined below appears only a partial contents of the book

25¢
the
Copy

THIS BOOK CANNOT BE BOUGHT ON THE NEWS- STAND — ONLY DIRECT FROM THE PUBLISHERS

Clip and Mail Coupon TODAY!

Publishers of RADIO-CRAFT, INC.—233
96-98 Park Place, New York, N. Y.

Enclosed you will find my remittance of 25c (check, stamps or money order accepted) for which you are to send me, postage prepaid, one copy of the RADIO-CRAFT INDEX.

Name

Address

City State

AMPLIFIERS—
General
Audio Frequency
Intermediate Frequency
Power
Radio Frequency
ANTENNA SYSTEMS—
CABINETS—
CIRCUITS—
Commercial
Experimental
CODE—
COILS AND TUNING—
COMPONENTS—
COOPERATIVE LABORATORY—
DETECTORS AND RECTIFIERS—
EDUCATION—
INTERFERENCE AND HUM ELIMINATION—
KINKS—
MANUFACTURING—
METERS AND TESTING EQUIPMENT—
MISCELLANEOUS—
MOTION PICTURE RECORDING AND PROJECTION—
MUSICAL INSTRUMENTS—
NEUTRALIZING—
NOVELTIES—

PATENTS—
PHONOGRAPH REPRODUCTION AND RECORDING—
POWER SUPPLY AND BATTERIES—
RECEPTION—
General
Airtel
Automotive
Broadcast
D. X.
Short-Wave
REMOTE CONTROL—
SELLING AND MONEY MAKING SERVICES—
General
Equipment
Operating Notes
Service Men's Data
SET CONSTRUCTION—
All-Wave
Automotive
Broadcast
Short-Wave
SPEAKERS AND REPRODUCERS—
TELEVISION—
General
Reception
Transmission

TESTING—
TOOLS—
TRANSFORMERS—
General
Audio Frequency
Intermediate Frequency
Power
Radio Frequency
TRANSMISSION—
General
Airtel
Beam
Broadcast
Short-Wave
TRANSMITTERS—
General
Airtel
Amateur
Broadcast
TUBES—
General
Penode
Photo-Cells
Testing
Thyratrons

LIST OF BROADCAST, SHORT-WAVE AND TELEVISION STATIONS—

ABSOLUTELY NOTHING WHICH HAS APPEARED IN RADIO-CRAFT HAS BEEN OMITTED FROM THIS VALUABLE COMPILATION

Build a TREASURE FINDER!



We supply
all Parts for Building
Electrical and Radio
**TREASURE
LOCATORS**

Radio, Audio, Ground Potential Measurements, Hughes Induction Balances and other types; including Oscillators and amplifying systems.

We supply all materials needed for building and operating any of the recognized treasure finders.

The following standard circuits are described in our bulletin:

- No. 1. Ground Potential, Leap-Frog Method.
- No. 2. Hughes Induction Balance Type A.
- No. 3. Hughes Induction Balance Type B.
- No. 4. Sensitive Hughes Induction Balance.
- No. 5. Simple Super-Sensitive Hughes Balance Circuit.
- No. 6. Radio Frequency Oscillator Circuit.
- No. 7. Audio Oscillator Circuit.
- No. 8. Single Search Coil Hughes Induction Balance with Audio Amplifiers.
- No. 9. Combination Radio Transmitter and Receiver circuit.

Also accessories such as High Frequency Buzzers, Audio Oscillators, Differential Current Transformers, Two Stage Audio Amplifiers, etc.

With any one of these systems you can locate buried treasures, metal war relics, mineral deposits, subterranean water veins, buried gas and water pipes, and lost objects, tools and treasures sunken in water, etc.

Write for pamphlet giving history and theory on this interesting subject. All above circuits and systems are described and explained. List of parts, and prices included. (Price of pamphlet 10c.)

Mail Coupon TODAY!

GREN PARK COMPANY
245 Greenwich St., New York, N. Y.

Enclosed find 10c for which kindly send me pamphlet on Treasure Finders.

Name

Address

City

State

METERLESS TESTER

(Continued from page 492)

prolonged operation, it should be mounted clear of other parts. If desired, the terminals of R5 may be brought out to binding posts, to furnish a source of about 180 v. rectified D.C., for testing condensers and for other uses.

List of Parts

- One 10-ohm fixed resistor, R1;
- One Remler 6-ohm rheostat and 0-10 dial, R2;
- One Remler 1,000-ohm tapped potentiometer and dial, R3;
- One Carter 100-ohm potentiometer and knob, R4;
- One .00025-mf. fixed condenser, C;
- Eight binding posts;
- One Leeds panel, lower half, 7 7/8x5 inches;
- One Leeds panel, upper half, 7 7/8x5 inches;
- (A single panel containing R2, R3, C, the eight binding posts, mounted on the lower panels is available in a single unit, known as Remler control panel type 330.)
- One Acme type VA2 audio transformer, variable ratio. Posts P1, B+4, F6, and G8 are used. AT.;
- One Leeds filament transformer, type FX, primary, 110 volts; secondary, two 2.5-volt windings, FT;
- One Na-Aid 6-prong socket, 6;
- Two Na-Aid 5-prong sockets, 5, (preheat);
- One Na-Aid 1-prong socket, 4;
- Two Na-Aid adapters, types 975KP. and 965CG;
- One H & H. D.P.S.T. toggle switch, S.W.1;
- One Marco S.P.S.T. off-on switch, S.W.2;
- Three H & H. S.P.D.T. toggle switches, SW.3, SW.4, SW.5;
- One lead and two binding posts, F1 (Fig. A);
- One screen-grid cap and post;
- One pin jack, PhB;
- One Leeds cabinet, 7 1/4x10x4 1/2 inches;
- One 7.5-volt "C" battery, accessory;
- One pair headphones, accessory.

Parts List for Rectifier Tester

- One Leeds power transformer, type 3724PX, primary 110 volts; secondary, 380 V.—0—380 V., 5 V., 2.5 V., PT.;
- One Electrad 2,000-ohm fixed resistor, 25 watt, adjusted to 1,800 ohms, R5;
- One Electrad 50-ohm potentiometer, R6;
- One Leeds dial for R6;
- One H & H toggle switch, off-on, SW.6;
- One H & H. D.P.D.T. toggle switch, SW.7;
- One Eby 1-prong socket, 4A (Fig. C);
- Two binding posts;
- One Leeds box, 7x4 1/2x4 1/2 inches;
- One Leeds panel, same size as box;
- One standard '27 tube.

SHORT CUTS

(Continued from page 483)

are taken exactly the same as with adapter. Simply connect the lower pin jack of either H or L, whichever range you are using, to chassis and plug in the cable.

The meter at extreme left is the output M. A. capacity and ohmmeter; next to the right is the D. C. voltmeter; beneath, in the center, is the point-to-point switch. The knob to the right is the low ohm adjuster while the knob below is the high ohm adjuster. The socket to the left of this is for the rectifier tube for the high range. The low and high pin jacks are already shown. The switch between the ohmmeter and voltmeter is simply a shorting switch for full-scale deflection and to quickly check for variations while making measurements, especially when using the high-range rectified D. C. as any line voltage fluctuations will throw you off considerably. The selector switch for the various ranges is above the rectifier socket.

COIL "Q"

● One of the most confusing symbols to the non-technical radio man is the so-called coil "Q." This letter merely symbolizes the ratio of the inductive reactance of the coil to its resistance at resonance. If the applied frequency is slightly different than the resonant frequency of the coil and its associated condenser, then the Q changes. The point, however, is that the Q never changes appreciably.

THE INTERNATIONAL

KADETTE Radio

A SENSATION!



The only radio that operates on any 110-volt circuit—AC or DC—25 or 60 cycle current.

—weighs only 5 lbs., carries like a camera.

—gives room-full volume—crystal clear and has superb tone.

—cased in genuine bakelite.

—a real distance-getter, too!

See it. Hear it. For sale at all good stores.

Complete with tubes . . . **\$25.00**

Carrying case \$1.50 extra.
De luxe models slightly higher.

Originated and manufactured by

INTERNATIONAL RADIO CORPORATION
Ann Arbor, Michigan



The New
**Meterless
TUBE
TESTER**

Now A C Operated
and portable

At Last

A Reliable Tube Tester

which can be built for..... **\$8.25**
complete kit including
two adapters

To Test 40 different types of tubes
(including hard to test 41—59—85
&c)

SEPARATE PARTS

Remler control panel.....\$1.70
Acme VA 2 transformer.....\$1.25
Leeds filament trans.....\$1.45

Optional Addition **\$4.25**
(kit)

handle and removable cover are
available

Mail Orders Filled Same Day. 10% cash
must accompany all C. O. D. Orders.



45D Vesey Street New York, N. Y.

2

USEFUL RADIO BOOKS WHICH EVERY EXPERIMENTER NEEDS IN HIS LIBRARY

There is not a radio man in the field, experimenter, service man or dealer, who will not want to read these two books. Right up to the minute with outstanding developments in short-wave radio—new methods and apparatus for quickly learning how to become a practical radio operator. Each book is authoritative, completely illustrated and not too highly technical. The text is easily and quickly grasped.

How to Become An Amateur Radio Operator

We chose Lieut. Myron P. Eddy to write this book because his long years of experience in the amateur field have made him pre-eminent in this line. For many years he was instructor of radio telegraphy at the R.C.A. Institutes. He is a member of the I.R.E. (Institute of Radio Engineers), also the Veteran Wireless Operators' Association.

If you intend to become a licensed operator, if you wish to take up phone work eventually, if you wish to prepare yourself for this important subject—this is the book you must get.

Partial List of Contents

Ways of learning the code. A system of sending and receiving with necessary drill words is supplied so that you may work with approved methods. Concise, authoritative definitions of radio terms, units and laws, brief descriptions of commonly used pieces of radio equipment. This chapter gives the working terminology of the radio operator. Graphic symbols are used to illustrate the various parts of radio circuits. General radio theory particularly as it applies to the beginner. The electron theory is briefly given, then waves, their creation, propagation and reception. Fundamental laws of electric circuits, particularly those used in radio, are explained next and typical basic circuits are analyzed. Descriptions of modern receivers that are being used with success by amateurs. You are told how to build and operate these sets. Amateur transmitters. Diagrams with specifications are furnished so construction is made easy. Power equipment that may be used with transmitters and receivers, rectifiers, filters, batteries, etc. Regulations that apply to amateur operators. Appendix, which contains the International "Q" signals, conversion tables for reference purposes, etc.

How to Build and Operate Short Wave Receivers

is the best and most up-to-date book on the subject. It is edited and prepared by the editor of SHORT-WAVE CRAFT, and contains a wealth of material on the building and operation, not only of typical short-wave receivers, but short wave converters as well.

Dozens of short-wave sets are found in this book, which contains hundreds of illustrations: actual photographs of sets built, hook-ups and diagrams galore.

The book comes with a heavy colored cover, and is printed throughout on first-class paper, particularly those used in radio, are explained next and typical basic circuits are analyzed. Dozens of short-wave sets are found in this book, which contains hundreds of illustrations: actual photographs of sets built, hook-ups and diagrams galore.

This book is sold only at such a ridiculously low price because it is our aim to put this valuable work into the hands of every short-wave enthusiast.

We know that if you are at all interested in short waves you will not wish to do without this book. It is a most important and timely new radio publication.

**Each Book Contains Over 150 Illustrations
72 Pages 7 x 10 Inches Not Sold on Newsstands**

Mail Coupon at Left for Books!



50¢ EACH

SHORT WAVE CRAFT
96-98 RC Park Place,
New York, N. Y.

Gentlemen: I enclose herewith \$_____ for which please send me, prepaid a copy of the book checked.

() HOW TO BUILD AND OPERATE SHORT-WAVE RECEIVERS—50c.
() HOW TO BECOME AN AMATEUR RADIO OPERATOR—50c.

Send money order, check, cash or new U. S. stamps. Register letter if it contains stamps or currency.

Name _____

Address _____

City _____ State _____

SERVICEMEN RADIO DEALERS

SEND FOR THIS
FREE 116 PAGE CATALOG!



IT'S CHOCK-FULL

OF BARGAINS FOR YOU
Radio Dealers and Servicemen can't afford to be without this book. It offers marvelous buys in Radio Sets, Long and Short Wave Apparatus, Servicemen's Repair and Replacement Parts, Electrical Goods, Sporting Goods.

JUST OFF THE PRESS!

Be among the first to have the pick of great bargains. Mail this coupon now!

RADIO CIRCULAR CO., INC.
225 Varick St.
New York, N. Y.

Dept. RC.

Please send me free of charge and without obligation, your latest catalog.

Name _____

Address _____

City _____ State _____

BOOK BARGAIN

Special Sale of
2000
S. GERNSBACK'S
RADIO ENCYCLOPEDIA
1st Edition

WE HAVE on hand
2000 UNBOUND
copies of this valuable
book, and we are disposing
of same at a price
which does not even
cover the cost of the paper and printing.

69c
THE BOOK

The books are in first-class condition, sewed and stitched but unbound. You can put a cover on yourself or your bookbinder can do it at a very small expense.

This indispensable radio reference book contains over 1,500 definitions, 549 photo reproductions, drawings, and diagrams. The size of the book is 9 by 12 inches. It contains 168 pages, and is printed on the finest book paper obtainable. Practically every definition in the book is illustrated, and all the subjects are arranged in alphabetical order with numerous tables and charts distributed throughout the text.

SEND NO MONEY NOW!

Do not send any money. We will send you the book and you pay the balance due plus postage. Cut out coupon, paste on postal card, and mail to:

ISKOR PRESS, Inc., 19 Park Place,
New York, N. Y.

BARGAIN ORDER BLANK

ISKOR PRESS, Inc. RC
19 Park Place,
New York, N. Y.

Please mail me S. Gernsback's Radio Encyclopedia, 1st Edition; Unbound. I will pay Postman 69c plus postage.

Name _____

Address _____

City _____ State _____

AMPLITENNA

(Continued from page 506)

not being directly connected to the centertap of filament winding X-X. The only remedy, in such cases, is to increase the capacity of condensers C1, C2A and C2B; in rare instances it may be necessary to use as high as 2 mf.

Mechanical Details

The shield case is held in position at the four corners by means of screws which thread into nuts sweated onto ell-shaped pieces of brass; one screw holding each ell to the metal base-plate extends far enough to catch the thread of a bakelite knob which acts as a support post for the chassis, raising it one-half inch so that screws, etc., will clear the surface below.

Volume control resistor R1 is held in place by means of an ell-shaped bracket which bolts to the chassis between L1 and L2. Chokes R.F.C.2 and R.F.C.3 mount on the power transformer by means of two little pieces of brass strip, cut and drilled to fit. The sockets for the 58's, and the twin binding post block, are held to the chassis by brackets. The filter condensers are held upright by means of clamp rings obtainable with the condensers; these rings bolt to the chassis. All the wires in the circuit thread through rubber grommets which prevent the edge of the shield-can cutting through the insulation. It is necessary to slot the shaft of the volume control, to provide for its initial adjustment by means of a thin screwdriver. Place a thin piece of bakelite or fiber between choke R.F.C.3 and the shield-can of the 82, to prevent sparking between them.

In closing, we caution constructors to pay particular attention to shielding, bypassing, and the positioning of the components. Test each unit for its rated value before connecting it into the circuit. The writers will be gratified to receive comments concerning the results secured with custom-built amplitennas, which are a new idea in radio.

List of Parts

- One Akaformer R. F. transmission. (One model A-502 antenna Akaformer. 50 ft. of shielded lead-in, one model A-503 set Akaformer);
- Two Dubilier "screen-grid" Duratron untuned R. F. transformers, L1, L2;
- One Hammarlund No. SPC shielded, polarized R. F. choke, 85 mhy., R.F.C.1;
- Two Sun type 82 unshielded R.F. chokes, 1. mhy., R.F.C.2, R.F.C.3;
- One Trutest type 2C1571 center-tapped 30 by. filter; choke, Ch.;
- One Trutest type 4C1497 power transformer, PT;
- One Clarostat type P185 wire-wound volume control, 10,000 ohms, R1;
- Three Centralab type 310 resistors, 275 ohms, R2, R3, R4;
- One Centralab type 310 resistors, 2 meg., R5;
- One Rite-Ohm No. 2275 voltage divider, 10,000 ohms, R6;
- One Aerovox type 281-T4 non-inductive condenser, 0.1-mf., C1;
- One Aerovox type 281-T4 dual-section condenser, 0.1-mf., C2A-C2B;
- One Aerovox type 481-T10 non-inductive condenser, 0.25-mf., C3;
- One Aerovox type 481-T10 dual section, condenser, 0.25-mf., C4A-C4B;
- One Aerovox type 1450 mica-dielectric condenser, .01-mf., C5;
- Three Concourse type V-8 small-space dry-electrolytic condensers, C6, C7, C8;
- Three CRC wafer-type 6-prong sockets, (for V1, V2, V3);
- One CRC wafer-type 4-prong socket (for V4);
- Three Eveready type ER-58 variable-mu R.F. pentodes, V1, V2, V3;
- One Eveready type ER-82 mercury-vapor rectifier, V4;
- Three Sun type 58 tube-shields, (for V1, V2, V3);
- One Sun type 82 tube-shield (for V4);
- One Blau special shield-can, 1/32-in. aluminum, 7x12 7/16x4 4/8 ins. high (outside dimensions);
- One Blau antenna-plate, 1/32-in. aluminum, 7x12 7/16 ins.;
- One R.T.Co. No. 3003 feed-through off-on switch, Sw.;
- One bakelite female plug, FP;
- One Littelfuse type 1037 fusible cap, MP;
- Two Littelfuse 1. A. fuses, (for cap MP);
- Flour Blau hard-rubber rods, 3x3/8-in.;

An Amazing Buy!

The name

STROMBERG-CARLSON

assures you of getting only the finest in radio.

Stromberg-Carlson

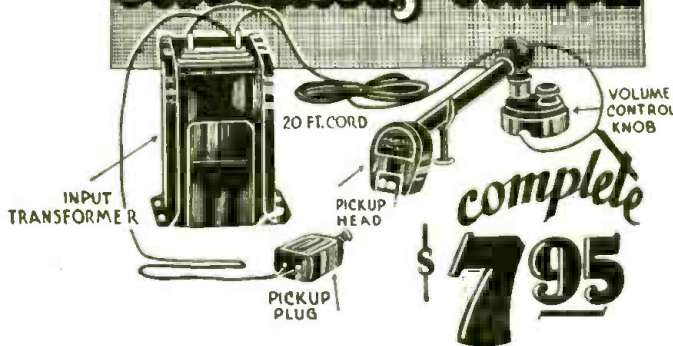

Exceptional Value!

As fine a pickup as has ever been made. This is being offered to you at an unusually low price.

There is nothing finer than a Stromberg-Carlson

Here is a phonograph pickup that will meet the requirements of the most discriminating. Made by a firm that is well known for high quality and well designed instruments. The tone arm is balanced for light needle pressure. A well designed input transformer, 20 foot cord, pickup plug and

volume control complete the assembly. Tone quality unsurpassed. Thousands in use in the best installations. This pickup can be used for home recording due to its low impedance. (200 ohms).

R. C. A. Magnetic Speaker Chassis

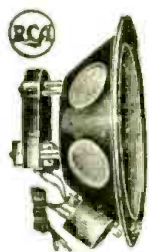

This chassis is the identical one used in the R.C.A. Model 100A and 100B Speakers. WHICH LIST FOR AS HIGH AS \$35.00. Note built-in OUTPUT TRANSFORMER—permits use of 450 volts, without distortion, rattling or blasting. **GENEROUS OVER-SIZED MAGNETS.** The thick armature is **ACCURATELY CENTERED.** The **STURDY METAL FRAME IS LINED WITH A SPECIAL SELF-BAFFLING FABRIC,** greatly improving acoustic properties of this sensational speaker! **NOTE THE CORRU-**

GATED SURFACE OF THE CONE, AN EXCLUSIVE FEATURE—ENHANCES PERFECT TONAL REPRODUCTION QUALITIES CONSIDERABLY: MOST COMPACTLY MADE: 9 inches OUTSIDE DIAMETER, 4 1/4 INCHES DEEP OVER ALL. **Your Price \$3.25**

PRIME A. C. MOTOR

For 110 Volts 50-60 cycle A. C.

A sturdy powerful compact heavy duty motor of the self-starting induction type. Will not set up disturbing noises in any receiver. Equipped with large bearing surfaces to provide adequate support and to insure long life. Quick starting, full speed is attained instantly. Comes ready to mount with turntable, mounting plate, on-off switch and speed control.



Your Price \$5.50

FARRAND INDUCTOR DYNAMICS

Used on A.C., D.C., and Battery Sets with Equal Results.

9" Model

\$5.95

12" Model

\$6.95



POWERTONE

Battery Operated Short Wave Receiver

TWO VOLT TUBES

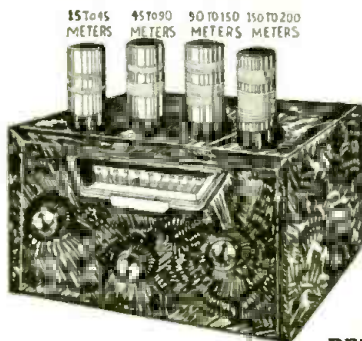

HAMMARLUND

CONDENSER

—15 TO 200 METERS

YES, stronger than ever, so do we voice our and countless other opinions on this remarkable shortwave battery operated receiver. Faster than ever in sales volume, for the public has caught up with us in voicing their enthusiasm on results with this receiver. Never before has reception such as this been available on any two or three tube battery operated shortwave set.

The use of the new two volt, air cell, tubes increase reception sensitivity, and selectivity, furthermore, current consumption is kept at a minimum. Provisions are made within the receiver to reduce three volts so that dry cells can be utilized.

The set itself is made up of the best parts available including a Hammarlund condenser for tuning purposes. The parts are sturdily mounted on a metal base, which in turn is placed into a beautiful crackle finished metal cabinet to completely shield its entire contents.

A set of four plug-in coils is furnished with the receiver and cover from 14 to 200 meters.

Truly does this set earn the statement "Round the World Reception."

Set of batteries, \$2.25

Set of R. C. A. licensed

tubes, \$2.50

\$9.95
WITH COILS

Victor Hand Microphone

Used with Victor R. E.-57 and R.C.A. 86 Home Recording Combinations

A single-button Microphone fine for home recording and amateur broadcasting. 100 ohm button. Operates from a 1 1/2 v. dry cell and draws 10 mils. Gun metal finish, equipped with 5 ft. cord.

Your Price \$2.45



MP D. C. MOTOR

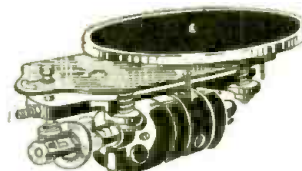

These motors are absolutely noiseless. Built as only motor manufacturers could know how, they are an epitome of phonograph manufacture. The ideal motor to use for recording. They have ample power to operate any recorder head. Completely equipped with speed regulator, cord and attachment plug, and a 12" turntable to take any size record.

Your Price \$7.95

BANQUET MIKE STAND

Extends from 18 to 30 inches. The ring will fit any standard size microphone. Due to a limited supply we advise you to get one at this low price.

Your Price \$3.50



All offers are F. O. B. New York, and subject to prior sale. Terms: A deposit of 20% is required with every order. Balance may be paid on delivery. Or, deduct 2% if full amount is sent with order.

GRENPARK CO.,

Dept. R. C.

245 GREENWICH STREET, NEW YORK, N. Y.

The Radio-Craft Library is now complete!

Presented on this page are the new books of the RADIO-CRAFT LIBRARY—the most complete and authentic set of volumes treating individually, important divisions of radio. Each book has been designed to give radio men the opportunity to specialize in one or more of the popular branches of the industry. The material con-

tained in these books will increase your knowledge; you will find them a real help in your work and they will contribute to your money earning capacity. Read these books during your spare time at home.

The authors of these books are well-known to everybody. Each one is an expert radio man; an authority on the

subject—each is thoroughly familiar with the field which he represents.

This is perhaps the first real opportunity that you have ever had to build a radio library of books that are authentic, right-up-to-the-minute and written so that they are easily digested and clearly understood. Mail coupon below for your books.

**TO THE RIGHT
WILL BE FOUND
A SHORT RESUME
OF EACH BOOK**

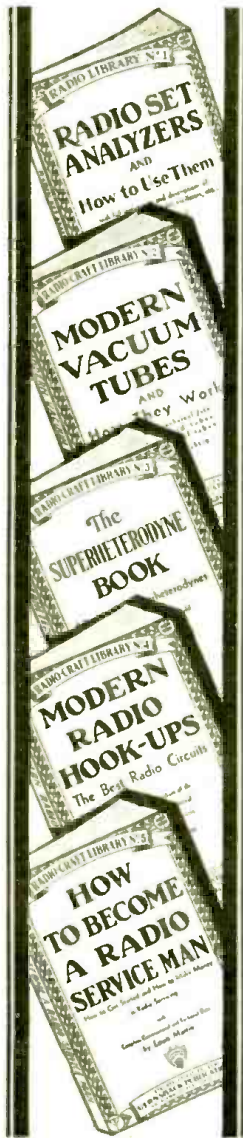

Book No. 1
**RADIO SET
ANALYZERS**

And How To Use Them
With Full Instructions and Descriptions of Set Analyzers, Tube Checkers, Oscillators, Etc.
By L. VAN DER MEL
This book explains thoroughly the operation of set analyzers, tube checkers, oscillators and other testing equipment. For every radio man this book is extremely helpful. It covers every phase of testing and gives you valuable short cuts; completely illustrated with photographs and diagrams to facilitate the use of modern testers.

Book No. 2
**MODERN VACUUM
TUBES**

And How They Work
With complete Technical Data on All Standard and Many Special Tubes
By ROBERT HERTZBERG
MODERN VACUUM TUBES describes the fundamental electron theory which is the basis of all vacuum tube operation, and goes progressively from the simplest two-element tubes right up to the latest pentodes and thyatrons. It is written in clear, simple language and is devoid of the mathematics which is usually so confusing. Valuable reference charts and characteristic curves of standard and special tubes are to be found, also diagrams of sockets and pin connections.

Book No. 3
THE SUPERHETERODYNE BOOK

All About Superheterodynes
How They Work, How to Build and How to Service Them
By CLYDE FITCH
There is no more fascinating a subject in the large array of radio circuits than the famous superheterodyne circuit. Whether you are a Service Man or experimenter, first-hand knowledge about the construction of superheterodyne receivers is very important. The book on Superheterodynes gives underlying principles of their construction, right from the very first set made.

Book No. 4
**MODERN RADIO
HOOK-UPS**

The Best Radio Circuits
A Complete Compendium of the Most Important Experimental and Custombuilt Receivers
By R. D. WASHBURNE
It is fascinating to the experimenter, or even to the up-to-date Service Man, to take a commercial set and to change it into one using a famous hookup that is not found in any manufactured set. Many excellent circuits have never been commercialized, but limited only to homeset builders. Thousands of these popular circuits have been requested from time to time, and in this book we have included over 150 circuits, which include the famous Perlman, Cash-Box A.C.-D.C. Set and others.

Book No. 5
**HOW TO BECOME A
RADIO SERVICE MAN**

How to Get Started and How to Make Money in Radio Servicing
By LOUIS MARTIN
The ambition of many men in radio today is to become a first-rate Service Man. It is not as difficult as one might believe, but it cannot be done in a few short months. Following very carefully the advice of Mr. Martin, who has dealt with the problems of thousands of Service Men, this book deals very carefully with the essential stages in the preparation for qualifying as a Service Man.

Book No. 6
**BRINGING ELECTRIC
SETS UP TO DATE**

With Pentodes, Multi-Mus, Dynamic Speakers—Complete Information How to Modernize A. C., D. C. and Battery Operated Receivers
By CLIFFORD E. DENTON
In this country there are over ten million electrically operated receivers that could be modernized—by placing in them new type tubes, new speaker equipment and other modern improvements. This business of improving old sets can go to the experimenters and Service Men if they will quickly jump into action.
Read in this book by Mr. Denton, how easily you can modernize any obsolete set, and with little additional costs.

Book No. 7
**RADIO KINKS AND
WRINKLES**

For Service Men and Experimenters
A Complete Compendium on the Latest Radio Short-Cuts and Money-Savers
By C. W. PALMER
If often becomes necessary for experimenters and Service Men to call upon their memory for some short cut or radio wrinkle that will solve a problem quickly. In business, "short cuts" mean time and money saved, and to the Service Man "time saved" means money earned.

This book is a compilation of important radio kinks and wrinkles and discusses only such items as are constantly used today.

Book No. 8
**RADIO QUESTIONS
AND ANSWERS**

A Selection of the Most Important of 5,000 Questions Submitted by Radio Men During the Course of One Year
By R. D. WASHBURNE

There have been collected a wide variety of questions which have come into our editorial offices during the past two years, and only those whose answers would benefit the majority of men engaged in radio have been incorporated in this amazing question and answer book. A tremendously long list of topics is treated.

Book No. 9
**AUTOMOBILE RADIO
AND SERVICING**

A Complete Treatise on the Subject Covering All Phases from Installing to Servicing and Maintenance
By LOUIS MARTIN

Automobile radios are up and coming, and someone has to service them properly. It therefore behooves you to read this immensely important new book on the art of Automobile Radio. The book is concise, and full of illustrations, photographs, diagrams and hookups.

A few of the really interesting chapters: Introduction; Automotive Radio Installations; Complete Descriptions of Commercial Automotive Receivers; Servicing Automotive Receivers; The Ignition System; General Service Considerations; Effects of Temperature on Power Supply; Conclusion.

Book No. 10
**HOME RECORDING
AND ALL ABOUT IT**

A Complete Treatise on Instantaneous Recordings, Microphones, Recorders, Amplifiers, Commercial Machines, Servicing, etc.
By GEORGE J. SALIBA

If there is one subject that is fascinating to every radio man, it is that of Home Recording. Of course, this volume is not all on "Home" recording, but the information contained therein is important to commercial radio men, studio operators, engineers and others interested in this phase of radio.

The art of recording and reproducing broadcast selections is becoming more important every day to radio men, experimenters and Service Men. Equipping dance halls, auditoriums, churches, restaurants and homes with public address systems and amplifiers brings many extra dollars and often an excellent income.

BIG DISCOUNT OFFERED

In order to make it possible for everyone to buy these books, the fifty (50) cent price has been made uniform for all volumes. You can buy these books separately, but you should take advantage of our special offer:

When Five (5) Books or More Are Ordered Deduct 20% from Your Remittance

Simply fill in the coupon below, and mail it to us together with your remittance. Checks, stamps or money orders accepted.

ALL BOOKS UNIFORM

The books in the new RADIO-CRAFT LIBRARY are all strictly up-to-date, and written by men who know their subjects. The volumes are all uniform size, 6x9 inches, and contain on an average of 50 to 120 illustrations. Each book is printed on fine book paper, and no expense has been spared to make it an outstanding value for its editorial contents as well as from the mechanical standpoint.

Clip Coupon and Mail Today!

GERNSBACK PUBLICATIONS, INC., 96-98 Park Place, New York, N. Y.

I have circled below the numbers of books in the RADIO-CRAFT LIBRARY, which you are to send me, and have deducted 20% for ordering five (5) books or more. I have included my remittance in full, at the price of 50c each, when less than five books are ordered.

The amount of my remittance is.....(Stamps, checks or money orders accepted.)
Circle numbers wanted: 1 2 3 4 5 6 7 8 9 10

Name Address

City State RC-2-33



FEBRUARY SPECIALS!!

EVERY month we list on this page certain **STAR** items, which are **NOT LISTED IN OUR CATALOG.** These are all specials of which the quantities on hand are not sufficient to catalog them. *Once sold out, no more can be had.* First come, first served. **ORDER NOW, TODAY.**

STOP SHOPPING. The lowest prices are right on this page. *No one undersells us.* We meet any price on ANY NEW Merchandise. Order direct from this page and save money. 100% satisfaction on every transaction. Take advantage of these special offers. **ORDER NOW, TODAY.**

IMPROVED READRITE MODEL 710 ANALYZER TESTS LATEST TYPE 6 AND 7 PRONG TUBES

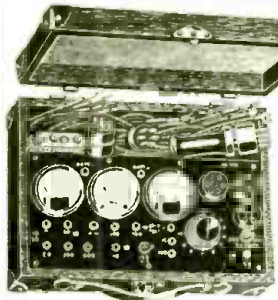

EIGHT METER SCALES AVAILABLE

The "Model 710" is an extremely compact device. The outside dimensions of the carrying case are only 10 3/4 by 7 3/4 by 3 3/4 inches. The analyzer contains a D.C. voltmeter, an A.C. voltmeter and a milliammeter. The D.C. voltmeter has three ranges: 0 to 60; 0 to 200; and 0 to 1000 volts. The A.C. voltmeter has also three ranges: 0 to 10; 0 to 140; and 0 to 700 volts. The milliammeter has two ranges: one for 20-mill. reading and the other for 100-mill. This variety of ranges makes it possible to test every conceivable radio circuit; high voltage secondaries of power transformers, current drain of all radio tubes, including the high power 250 and 210 tubes, etc.

The instrument is equipped with a six-position bi-polar selector switch, by means of which readings may be obtained of "A" volts, "K" volts reversed, "K" volts, "R" volts reversed, plate voltage, and screen-grid voltage. A 4 1/2-volt battery is supplied with the analyzer, to provide "C" bias, for grid tests, continuity tests, etc.

TESTS PENTODES—"MULTI-MUS" '57's and '58's—and '80 RECTIFIERS There are two sockets on the panel of the analyzer, one for four-prong tubes and the other for five-prong tubes. There is a "grid-test" push-button. Pin jacks are available for the individual use of all meters, externally. In every range, there is a screen-grid pin jack for connecting the external battery. A two-way toggle switch controls the testing circuit for either regular or pentode tubes. Both plates of the '80-type rectifier may be tested by use of a special adapter furnished. Charts are provided for measuring resistances and capacities. The Analyzer is furnished complete with test leads, connecting cables, Burgess 4 1/2-volt battery, several battery leads, 1-Y to 1-X adapter, '80 rectifier adapter and resistance and capacity charts. Shipping weight, 8 lbs.

Model 710 Analyzer. List Price, \$36.
YOUR PRICE

READRITE COMBINATION TEST INSTRUMENTS

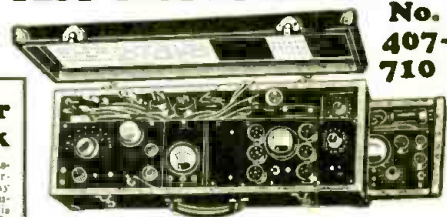

No. 407-710

FREE Analyzer Book

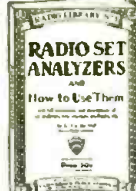

We take pleasure in offering with any test instrument on this page a **FREE ANALYZER BOOK**—the entire price of which is **CHARGED**—to come off the price of the "Radio Set Analyzers" Contains detailed descriptions, photographs and circuit diagrams of all commercial radio analyzers and testers.—A Real Book.

Complete Portable Laboratories

For the first time in the history of radio, complete portable testing equipment is being sold in the low-priced meter field. Every conceivable test necessary for radio, television and general electrical work may be made with either of these two units. The 406-710 instrument combines in a single case, 21" x 14" x 7 1/2" the No. 406 Tube Tester and the No. 710 Set Analyzer. Every radio tube that has so far been brought out can easily be tested by either of these two outfits.

Four Models are available in following combinations:

No. 406-710 Tube Tester and Set Analyzer	\$29.40
No. 407-710 Tube Tester—Tube-Short Tester and Set Analyzer	32.34
No. 576 Tube Tester—Set Analyzer—Oscillator	50.00
No. 577 Tube Tester—Tube-Short Tester—Set Analyzer—Oscillator	52.92

\$14.70

THORDARSON "215" POWER TRANSFORMER

A Miniature Power Plant—Supplies All ABC Voltages
Service Men and experimenters! Here is the transformer which will enable you to turn into money that old stock of radio sets equipped only for 125v. 7 1/4 tubes, whether single- or push-pull by replacing them with 45's.
Compare the ratings of the '71A and the '45. The former has an audiotester output of only 700 milliwatts while the type 45 powered tube also operating at its rated plate potential, has a power output rating of 1,800 milliwatts.
In addition to supplying a full 250 volts to the plates and 60 volts to the grids of two type 45 tubes in push-pull, the Thordarson power transformer may be used to light the filaments of seven or eight 2.5-volt filament tubes; and by connecting in series two of the three 2.5-volt filament secondaries it is possible to light 5-volt filament tubes. This transformer is a genuine Thordarson job put up in Philco No. 3400 shield plates.
Thordarson Transformer has bakelite panel on which are mounted all taps in form of soldering lugs. Filament supply only. For 110-120 volts, 50-60 cycles. Size 5" high x 4 1/4" wide x 3 3/4" deep. Shipping weight 1 lb.

No. 1450 Thordarson Power Transformer. **YOUR PRICE \$3.25**

JUST OFF THE PRESS!

FREE RADIO AND SHORT WAVE TREATISE

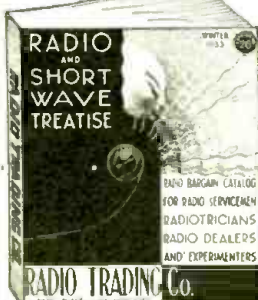

The new Winter, 1933 edition of our Radio and Short-Wave Treatise, No. 28 has just been published. It contains 100 solid pages of useful information, radio items, diagrams and illustrations. Positively the best thing you can get—**NOT JUST ANOTHER CATALOG.** Contains a large editorial section with valuable information not found anywhere else. Special consideration has been given to the radio beginner in this issue. Among the new technical information listed are the following:

HERE IS A PARTIAL LIST OF CONTENTS
Fundamental Principles of Radio—Ohm's Law—Discussion of New Tubes—Constructing a "Triple-Twin Amplifier"—All about Superheterodynes—Eliminating Man-Made Static—Constructing a Two-Tube Short-Wave "Globe Trotter" Receiver—\$3.00 Prize Suggestions—Radio Kinks, etc., etc.

Over 100 New Hook-Ups, Etc. 1000 Illustrations.

WRITE TODAY. Enclose 1 cent for postage. Treatise sent by return mail.

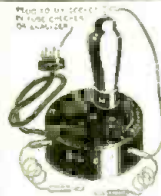

UNIVERSAL MULTIDAPTER

Tests All the Latest As Well As Future Tubes
Here is a unit which every serviceman should have on hand. It is a multidapter which completely modernizes old or obsolete tube checkers and analyzers by enabling them to test not only the more of new tubes, but tubes which will be forthcoming in the future as well. TESTS all the new tubes including types 29-33-39-41-42-43-46-47-55-57-58-64-65-69-82-83-89 and second-plate of 90, etc. You need only one Multidapter, but without it you need many adapters. The Multidapter is a perpetual type of adapter as provision is made for testing all new tubes that might be brought out in the future in either of the 4, 5, 6 or 7 prong tubes. It will be up to date in the future as well as the present time.
Available in two models; one which plugs directly into either the tube tester or analyzer and the other which has an extension plug. Used in connection with such instruments which do not have enough room for plugging in the adapter directly. Complete instructions for using this adapter are furnished free with each unit.

No. 203 Multidapter with attached Plug **YOUR PRICE \$2.75**
No. 204 Multidapter with Extension Plug **YOUR PRICE 2.95**

Kellogg Dynamic Push-Pull Output Transformer

For '71A, '45, '50 Type Tubes

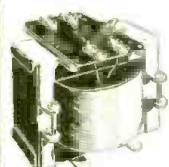

The Primary of this output transformer has unusually high impedance, making it suitable for all types of tubes. The secondary feeding into the tuning eye coil of a dynamic speaker, giving a 13:1 resistance between 2 and 8 ohms. Clamping brackets holding the transformer in perfect order, is incorporated in wax compound to insure long life without breakage. Size 3 1/2" x 2 1/2" x 3 1/2". Ship. wt. 3 lbs.

No. 1462 Kellogg Push Pull Output Transformer. **YOUR PRICE \$0.59**

FOOL-PROOF SHORT-WAVE SET

Doerle Two-Tube 12,500 Mile Receiver

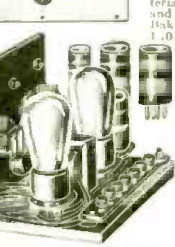

Although a low-priced receiver, this instrument pulls in short-wave stations from all over the world, RELIABLY, in practically any location, not only in this country, but anywhere.
Size of aluminum panel is 9 1/2 inches high, 9 x 5 1/4 inches. List of materials used: 2 Hameilton 90014 Condensers; 1 Carter 20 ohm resistor; 1 set of switches; 1 Ferris Audio Transformer; 2 Kuetz-Kash Varier Dials; 3 Bakelite Low Loss Sockets; 1 Mircaloid Equalizer Antenna Condenser; 1 0001 Aerovox Fixed Condenser; 1 aluminum panel; 1 veneer baseboard; 1 Bakelite Rheostat; Knob; 1 Bakelite Blending Post Strip; 1 set of 4 Bakelite Short Wave Plug-in Coils; instructions for operation; 1 set of 2 telephone pin jacks. Complete shipping weight 5 lbs.
TWO-TUBE 12,500 MILE DOERLE WAVE RECEIVER, completely wired and tested as per above specifications. YOUR PRICE \$8.90
TWO-TUBE 12,500 MILE DOERLE SHORT WAVE RECEIVERS KIT, with all parts as specified above, but not wired, with laboratory connections and instructions for operation. Complete shipping weight 5 lbs. YOUR PRICE \$7.70
Complete set of accessories, including the following: 2 six months simulated Neontron type No. 230 tubes; one set of No. 1678 Branda Marched Headphones; 2 No. 6 standard dry cells; 2 standard 45-volt "B" battery; Camard plates. Shipping weight 22 lbs. **YOUR PRICE \$5.40**

Merrshon Electrolytic Condensers

Merrshon Electrolytic Condensers maintain their characteristics over wide ranges in temperature. Rated at 475 volts peak, they are recommended for filterneck work and for bypassing "C" bias resistors in AF circuits, especially bias resistors of power tubes. Perform miracles in eliminating A. C. Hum. The advantages of capacitor bypassing in AF circuits have always been realized but the cost of high capacity paper condensers has been too high. Now that this price obstacle has been eliminated, these units should be used generously. Available in 5 sizes as listed. Complete with mounting nut and lock washer. Shipping weights vary from 1/4 lb. to 1 1/4 lbs.

No.	Capacity	YOUR PRICE
2404	4-mf.	\$0.45
2406	6-mf.	\$0.50
2408	8-mf.	\$0.60
2410	10-mf.	\$0.70
2412	12-mf.	\$0.80

Metallized Pigtail Resistors



Values Clearly Marked on Each Unit
Guaranteed to maintain their ohmance under adverse operating conditions.
Available in the following sizes, all rated at one watt: 500, 1000, 2000, 5000, 10,000, 20,000, 50,000, 100,000. Act fast to take advantage of this offer as the supply is limited. Sold only in lots of six or more.
No. SP2226. Metallized Resistors. **YOUR PRICE 12 for 60c.**

"LITTLE GIANT" DYNAMIC SPEAKER



Suitable for use on midsize portable and auto-mobiler receivers. Measures but 6 1/2 inches long, 4 1/2 inches wide and weighs but 4 lbs. Field winding has a resistance of 2500 ohms and may therefore be energized by using it as a filter choke in the power pack thereby serving a double purpose. Equipped with built-in output transformer to work from any standard output power tube arrangement. Specify the power tube or tubes used when ordering. Shipping weight 5 lbs. List Price \$6.50.
No. 1549. Little Giant Dynamic Speaker. **YOUR PRICE \$2.50**

Jefferson Power Pack—Choke Unit



Consists of a standard Jefferson Power Transformer and a 30 henry 500 ohm filter choke. Both mounted sturdy, compact metal case.
JUST THE THING TO CONVERT OLD TYPE BATTERY SETS INTO MODERN ALL-ELECTRIC AC RECEIVERS.
Transformer designed for 110-120 volts 50-60 cycles operation, and has the following specifications: 2 volts at 2 amps, 5 volts C. T. at 0.5 amp, 1 1/2 volts at 5.25 amps, 2 1/2 volts C. T. at 3.5 amps, and 500 volts C. T. at 0.0 mill. Instructions included. Ship. wt. 10 lbs.
No. 1499 Jefferson Power Pack Choke Unit. **YOUR PRICE \$2.45**

UTAH A. C. DYNAMIC SPEAKER



Operates from 110 volt 60 cycle A. C. line, 9" high by 9 1/2" wide by 7 3/4" deep. Complete with Westphal "Recto" Dry Disc Rectifier and output transformer for a single 177A, 245, 210 or 250 power tube. No. 1516. **YOUR PRICE \$6.95**

#85 Millihenry Choke Coil

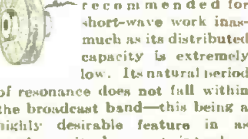

This choke coil is recommended for short-wave work inasmuch as its distributed capacity is extremely low. Its natural period of resonance does not fall within the broadcast band—this being a highly desirable feature inasmuch as it does not introduce "cut-off" disturbances. Consists of 1800 turns of helically wound enameled wire. Measures 1 3/4" in diameter x 3 1/2" thick.
No. 1681 85 Millihenry Choke Coil. **YOUR PRICE \$0.12**

WE ARE A WHOLESALE HOUSE AND CANNOT ACCEPT ORDERS FOR LESS THAN \$3.00. If C.O.D. shipment is desired, please remit 20% remittance, which must accompany all orders. If full cash companies order, deduct 2% discount. Send money order—certified check—U. S. stamps.

Radio Trading Co.
102 Park Place
New York, N. Y.

ORDER FROM THIS PAGE. You will find special prices from time to time in this magazine. Get our big FREE catalog for the greatest Radio Bargains.
Should you wish goods shipped by parcel post, be sure to include sufficient extra remittance for same. Any excess will be refunded.

HERE'S THE GUARANTEE

that built the largest institution of its kind in the world of

RADIO!

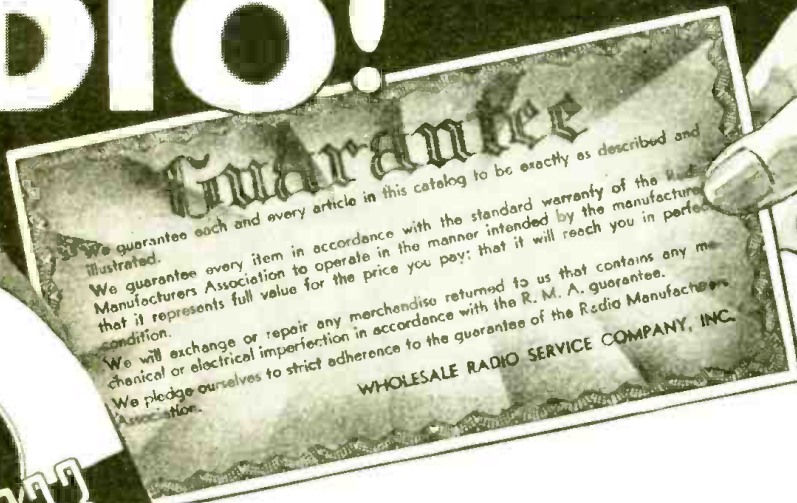

NO RADIO SERVICE IS GREATER THAN THE COMPANY BEHIND IT!

WHOLESALE RADIO SERVICE COMPANY, the oldest, largest institution of its kind in the world, has been established in the radio field for over 11 years. Thousands of radio service men and dealers all over the world keep in touch with the newest developments in radio through the medium of our catalog.

This NEW Catalog
SENT FREE!

We invite you to write for a FREE copy of the new 1933 WHOLESALE RADIO catalog—bargain book of the radio industry. Anything and everything in radio—no matter how big or small. A complete line of LAFAYETTE RECEIVERS, short-wave, long wave and broadcast models. In a splendid selection of mantel and console cabinets. TRUATEST PARTS of super-fine quality—and a COMPLETE LINE OF REPLACEMENT PARTS FOR EVERY SET.

Mail the coupon today. It will bring you, without charge, the new 1933 WHOLESALE RADIO CATALOG.

Everything we sell—radio sets, tubes, speakers, kits, accessories, public address systems, amplifiers, replacement parts, etc., is backed by the nationally known WHOLESALE RADIO SERVICE COMPANY GUARANTEE—a guarantee that means what it says—that is your protection and assurance of 100 per cent satisfactory dealings. We guarantee to please you—to give you what you order—we never substitute. Furthermore we guarantee our merchandise to be absolutely as represented—free from defects. Our prices are always consistently low—they meet and beat competition. Our customers reap the benefit of current price reduction made in the field—prices are re-

duced and refunds made whenever any prices are lowered—even though our catalog price is already printed).

And—since no guarantee is worth more than the company behind it—WHOLESALE RADIO SERVICE COMPANY offers you the additional protection of a large, well established, financially strong organization, with tremendous resources. We invite you to look us up—investigate our reputation and credit standing—find out for yourself why our slogan "THE RELIABLE HOUSE OF RADIO" means honest dollar for dollar value and the quickest, fastest service in the radio field.

Featuring

an especially fine line of PUBLIC ADDRESS SYSTEMS and AMPLIFIERS—which offer an exceptional opportunity to capitalize on the tremendous current interest in PUBLIC ADDRESS.

WHOLESALE RADIO SERVICE CO., INC.
100 SIXTH AVE. NEW YORK

Mail Coupon TODAY

WHOLESALE RADIO SERVICE CO., Inc.
100 Sixth Ave., Dept. C-23,
New York, N. Y.

I shall be glad to receive a FREE copy of your new 1933 radio catalog. Please mail it immediately.

Name _____
Address _____
Town _____ State _____

TUBE CHARACTERISTICS

Francisco Pinto Basto*

In reference to the article of Mr. C. H. W. Nason, entitled "Tube Characteristics at a Glance," published in the August issue of your journal, insert page 128A, I would like to submit to RADIO-CRAFT a handy, graphic chart for tube characteristics. I have never seen such graph in any paper; only in the "Telefunken Zeitung," April, 1930 is shown together with the triangular chart another graph employing log-log paper, where the penetration factors (in German—Durchgriff = $1/\mu$) are marked as abscissae and the resistances as ordinates, and the mutual conductances are given by a 45° lines net.

In my chart, Fig. 1, a log-log paper is also used. As abscissae (A) are marked the amplification factors and as ordinates (B) the mutual conductances in mA per volt. The A. C. resistances are given in $k\Omega$ by a family of straight lines (C) easy to construct.

For better comparison of power tubes, another family of 45° lines, perpendicular to the former, may be drawn. These lines (D) will give the maximum power output per peak volt squared input that a tube can deliver: $\frac{P}{E_i^2} = \frac{\mu^2}{8R_p}$. To avoid a complexity of lines, only the lines for 1, 10 and 100 milliwatts per square volts (peak) are set up. The power subdivisions P may be read on a resistance line, say, on the 1 $k\Omega$ line. Together with the milliwatts scale is inscribed a decibels scale (E) having the 0 level in 1 milliwatt per square volt, but any other level may be used.

Any tube is represented by a point which gives at a glance the three parameters: μ , mutual conductance, and resistance.

Now, suppose that we wish to compare two power triodes, for instance, the '10 and the '50. The graph shows (dotted) that the '10 gives 5 decibels above the level and the '50 3 decibels. It is to be noted that a triode gives 0.4- to 0.8-decibel less if the undistorted output is considered because the load is twice or three times the A. C. resistance. Without great error we can assume a 0.5-dB. loss for all the triodes; consequently it may be taken into account merely the decibels difference of the two tubes and we say that the '10 gives 2 decibels more per square volt input than the '50. If the largest input voltage to be handled is low enough not to overload the '10, this tube will be preferable to the '50.

For identical power pentodes this simple comparison may be made, but if we compare a triode and a pentode, a deduction of 2 (to 4) db. must be made from the pentode's power, due to the fact that the pentode requires a load 5 (to 11) times less than the A. C. resistance. By this means the graph indicates for the '47 (deducting 2 db.) 13 db undistorted output more than for the '45, for the same grid swing.

Another family of 45° lines, perpendicular to the resistance lines may be constructed, giving the R. F. Performance Factors: $F = \frac{\mu}{\sqrt{R_p}} 100$; only the scale (F) R. F. P. F. is plotted on the 10 $k\Omega$ line.

In radio frequency, it is well-known that the maximum voltage gain obtainable with a tube followed by a suitable transformer is given by $G = \frac{1}{2} \cdot \frac{\mu}{\sqrt{R_p}} \cdot \sqrt{R_d} = \frac{1}{200} F \sqrt{R_p}$ provided that the turns ratio of the transformer is properly adjusted ($N = \sqrt{\frac{R_d}{R_p}}$), where $R_d = \frac{w^2 d^2}{r}$ is the dynamic resistance of the coil and R_p the A. C. resistance of the tube, w L and r being respectively the inductive reactance and the radio frequency resistance of the coil.

Hence, factor F may give a fair idea of the maximum voltage gain that we can obtain with an R. F. transformer coupled tube.

A little investigation shows readily that the decibels scale may be used to give a computation of the gain obtainable with a given radio frequency tube.

If G. is the voltage gain, the decibels gain is given by $db = 20 \log G = 10 \log G^2 = 10 \log \frac{\mu^2}{R}$

As the decibels scale divisions are proportional to $\log \frac{\mu^2}{R}$, it may be used also for this case.

The power lines may be plotted also in the triangular chart, referred to in the August issue, but it will be very laborious work.

Other charts employing log-log paper may be constructed, for instance, with μ as abscissae and R_p as ordinates.

*Lisbon, Portugal.

POST CARD

PLACE
1c
STAMP
HERE

WHOLESALE RADIO SERVICE CO.

Dept. C23
100 Sixth Avenue
NEW YORK, N. Y.

POST CARD

PLACE
1c
STAMP
HERE

Mr. H. C. Lewis, President
Coyne Electrical School, Dept. 23-8H
500 South Paulina Street
CHICAGO, ILL.

POST CARD

PLACE
1c
STAMP
HERE

McMurdo Silver, Inc.
1130 W. Austin Avenue
CHICAGO, ILL., U. S. A.

POST CARD

PLACE
1c
STAMP
HERE

International Correspondence Schools

Box 6678

SCRANTON, PEN

TUBE DATA CHART



The Great New WHOLESALE RADIO Catalog! Smashing Selection of 1933 Values!

February RADIO-CRAFT Wholesale Radio Service Co., Inc., 100 Sixth Avenue, New York, N. Y.

Attention: Dept. C23

I shall be glad to receive a FREE copy of your NEW 1933 Radio Catalog. Kindly mail it immediately.

Name Address Town and State

February RADIO-CRAFT

Mr. H. C. Lewis, President Coyne Electrical School Dept. 23-8H, 500 So. Paulina St. Chicago, Ill.

Without obligation send me your big free catalog and all details of Railroad Fare to Chicago, Free Employment Service, Radio, Aviation, Electricity, and Automotive Courses, and how I can "earn while learning" as per your advertisement in RADIO-CRAFT.

ALSO TELL ME ABOUT YOUR "PAY AFTER GRADUATION OFFER."

Name Address City State

February RADIO-CRAFT

McMurdo Silver, Inc. 1130 W. Austin Avenue Chicago, Ill., U. S. A.

Please send technical description of The Masterpiece.

Name Address Town State

CHOOSE YOUR CAREER

- Architect, Architectural Draftsman, Building Foreman, Concrete Construction, Contractor and Builder, Structural Draftsman, Structural Engineer, Structural Steel Worker, Electrical Engineer, Electric Wiring, Electric Lightings, Electric and Gas Welding, Telegraph Engineer, Telephone Work, Mechanical Engineer, Mechanical Draftsman, Machine Shop Practice, Reading Shop Blueprints, Toolmaker-Boilermaker, Civil Engineer, Aviation Engineer, Diesel Engine, Plumber and Steam Fitter, Plumbing Inspector, Foreman Plumber, Heating and Ventilation, Sheet Metal Worker, Steam Engineer, Steam Electric, Marine Engineer, Refrigeration, Highway Engineer, Chemistry, Mining, Lumber Dealer, Woolen Manufacturing, Agriculture, Surveying and Mapping, Bridge Engineer, Gas Engine Operating, Automobile Work, Fruit Growing, Poultry Farming, Mathematics, Business Management, Office Management, Industrial Management, Personnel Management, Traffic Management, R. R. Section Foreman, R. R. Bridge & Building Foreman, Accountancy, Cost Accounting, Certified Public Accountant, Bookkeeping, English, Spanish, French, Salesmanship, Advertising, Business Correspondence, Complete Commercial, Show-Card Lettering, Stenography and Typing, Civil Service, Railway Mail Clerk, Mail Carrier, Grade School Subjects, High School Subjects, Carwomane, Illustrating, Lumber Dealer.

February RADIO-CRAFT

International Correspondence Schools, Box 6678, Scranton, Penna. Please tell me how I can succeed in the career I have checked and send me, FREE OF CHARGE, your catalog and a copy of

"Who Wins and Why"

Name Street and No. City State Occupation Employed by Age

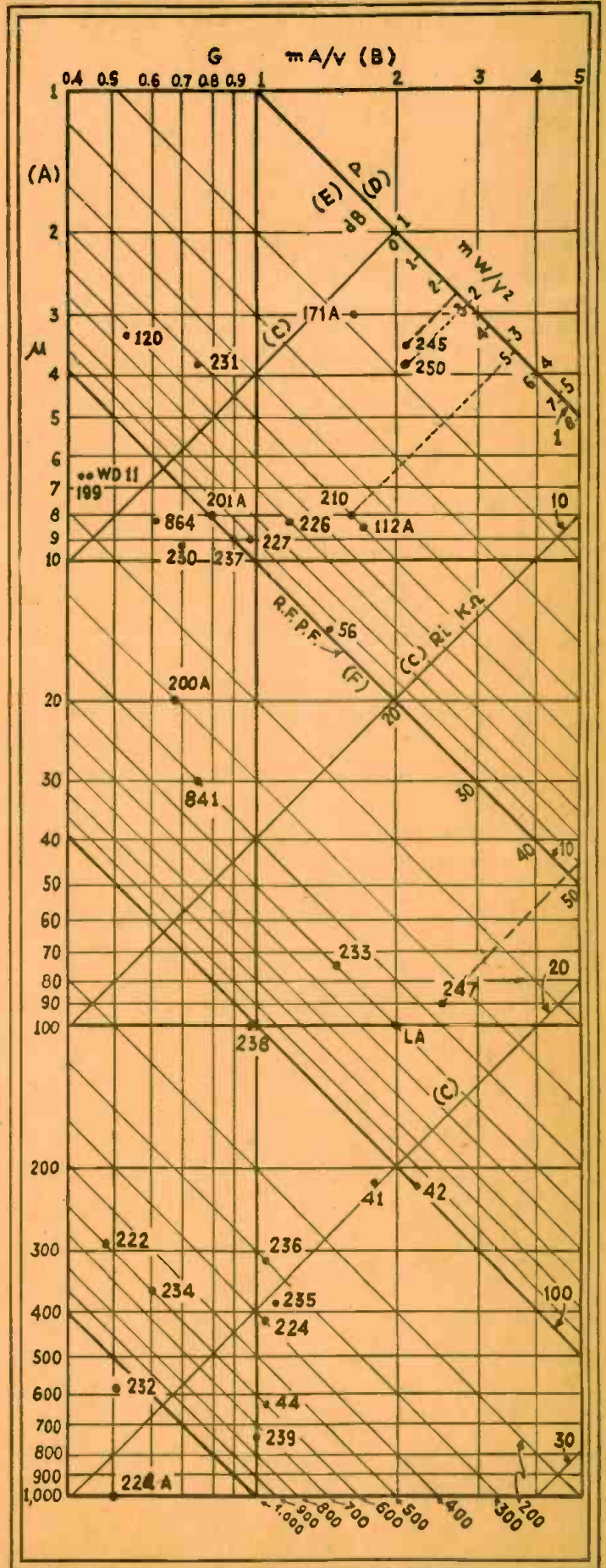

Fig. 1 A graphic representation of the following factors of tubes: amplification factor, mutual conductance, plate resistance, power output in milliwatts, power output in decibels, and R.F. performance factor. Forthcoming tube characteristics may be interpolated as the data becomes available. This procedure is discussed on the preceding page, and in the August, 1932 issue of RADIO-CRAFT.

Send for FREE Booklet

They Have Copied Everything—

Except **CERTIFIED TRIAD Quality**

IT IS WRITTEN—

“Imitation is the sincerest form of flattery”

TRIAD

Appreciates the compliment it receives each month from other tube manufacturers who have copied our sales plan—our method of advertising—our discount schedules

TRIAD

Was first to recognize the Service Man

TRIAD

Was first to make double-tested tubes

TRIAD

Was first to offer a plan which really makes money for the dealer and Service Man

OTHERS

have made every effort to do the same thing

BUT

THEY HAVE NOT BEEN ABLE TO DUPLICATE

CERTIFIED

TRIAD → Quality

TUBES

A NEW DEAL

Some of our Service Men and Dealers have wanted to buy regular Triad Tubes to meet ordinary competition—

We have worked out a special proposition with most attractive discounts, and will be glad to supply the details upon request.

With regular Triads and Certified Triads you can beat any kind of competition.

CERTIFIED Triad Dealers and Service Men everywhere have sold many thousands of these tubes,—they are making money—there hasn't been a single complaint. Mail the coupon today and learn how you can sell these super-grade tubes at a real profit. We protect you in your territory and you are sure of all of the inducements offered by other manufacturers, plus quality which is in a class by itself. **GET THE FACTS!**

TRIAD Manufacturing Co.
Pawtucket, R. I.

Gentlemen:

Please send me the outline of the CERTIFIED TRIAD Sales Plan for Dealers and Service Men.

Name.....

Address.....

City.....State.....

My letterhead or business card is attached

Super Power

GUARANTEES

*To You Every Bit of Performance Possible
Under Prevailing Atmospheric Conditions*

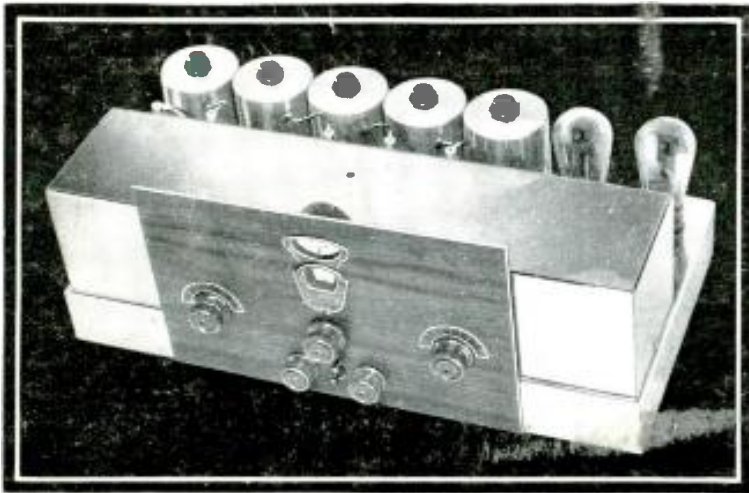

Lincoln De Luxe
All Wave Superheterodyne

15 TO 550 METERS

With undistorted amplification made possible thru Lincoln's foresight in development of new triple push pull detector and audio system.

Automatic Volume Control

Signal Indicator

Four High Gain I. F. Stages

BRING THE WORLD RIGHT INTO YOUR HOME

with proven equipment used by the MacMillan Polar Expedition, Commercial Experts and Individuals the world over.

SUPER POWER of the New Twelve-Tube Lincoln DeLuxe SW-33, coupled with the new Lincoln developments, guarantees to you real radio reception of unlimited distance.

If you have never tuned the new Lincoln you have missed the treat of your life.

Just tune to a European station which ordinarily fades completely out at times, and note how the Lincoln new automatic volume control holds the signal at a perfect level.

Watch the signal indicator register the weakest signal, and then tune to the exact center of the carrier wave with absolute precision.

When you wish to tune late at night, open up the sensitivity control wide, and reduce volume control to whisper.

Throw in the 53 to 1 ratio on the dial for ease in tuning high frequencies.

Open up the volume control to the limit and shake the floor with the tremendous amplification without distortion.

Listen to the heavy bass vibratory notes produced by the use of the push-pull detector followed by two stages of push-pull audio and reproduced in the finest auditorium type speaker we can procure.

Note the high sensitivity provided by four tuned stages of intermediate amplification—just tune in a foreign station—you will want the volume control opened only a few degrees.

Just note what a recent Lincoln owner in Java (a country with extremely bad weather conditions, and mineral deposits, making high noise interference) says about the new Lincoln: "Foreign stations come in very loudly! Paris, Rome, Zeesen, Konig-

swusternaussen, Chelmsford and a score of other European stations come in clearly; Sydney, Queensland and Melbourne from Australia can be received with great volume; JIAA from Japan is consistently heard, while Pittsburgh and Schenectady have been received. Also on the broadcast band daily reception can be had from several European stations, Japan, Manila and China. I have heard of no other set that can equal your Lincoln."

Owners of the first Lincoln models are still proud of their performance.

BATTERY RECEIVER uses eleven (11) two-volt tubes, and can be used in connection with the Air Cell or storage batteries.

Mail the coupon for Laboratory information and price. New York City territory write Valentine G. Hush, Division Drive, Dobbs Ferry, N. Y.

LINCOLN RADIO CORPORATION
Dept. RC-2, 329 S. Wood St., Chicago, Ill.

Please send information on A.C. D.C. receivers.

Name

Address

City State

Print name and address plainly

LINCOLN
DeLuxe Receivers